



A NOVO Building Products Company



Open up to Inspiration!

L.J. Smith then . . . and now!

We are honored to have this opportunity to share with you a little bit of our history, as well as some information about the quality and craftsmanship we build into our products every day.

L.J. Smith's heritage of American craftsmanship reaches far back in time. It all began in 1885, when a gentleman, by the name of L.J. Smith, began making staircases and the stair parts for each in Pittsburgh, Pennsylvania. In 1911, he moved his family to Conotton, Ohio, to continue the stairway business as "L.J. Smith and Son." L.J. Smith and his son, along with seven other craftsmen, were very busy keeping up with the demand for their meticulously crafted circular stairways that were going into large homes throughout the south.



Following the death of L.J. Smith, in 1942, the company continued to thrive under the leadership of his son until, in 1977, the Smith family sold the business.

The following decade offered tremendous growth opportunities for the company. The rising demand for our circular stairways and

stair parts lead to the construction of a new and much larger manufacturing facility located near Bowerston, Ohio, in 1989.

The new facility was utilized for the manufacturing of stair parts, while the original structure was renovated to accommodate the custom stair division of L.J. Smith, Inc.

Since 1991, L.J. Smith has made many strategic acquisitions and currently has 8 locations, four of which are complete manufacturing facilities, throughout the country in order to meet the needs of their valued customers.

Today, L.J. Smith is the largest stair parts manufacturing company in the country. Our continued growth over the past several decades is clearly a result of our leadership role in developing and taking to market new and innovative products & techniques. We have patents or patents pending on nearly two dozen products and processes. Our most recent innovations include: hardware to easily remodel stairways from wood balusters to iron balusters; half wall box



L.J. Smith's Time line of Innovations. . .

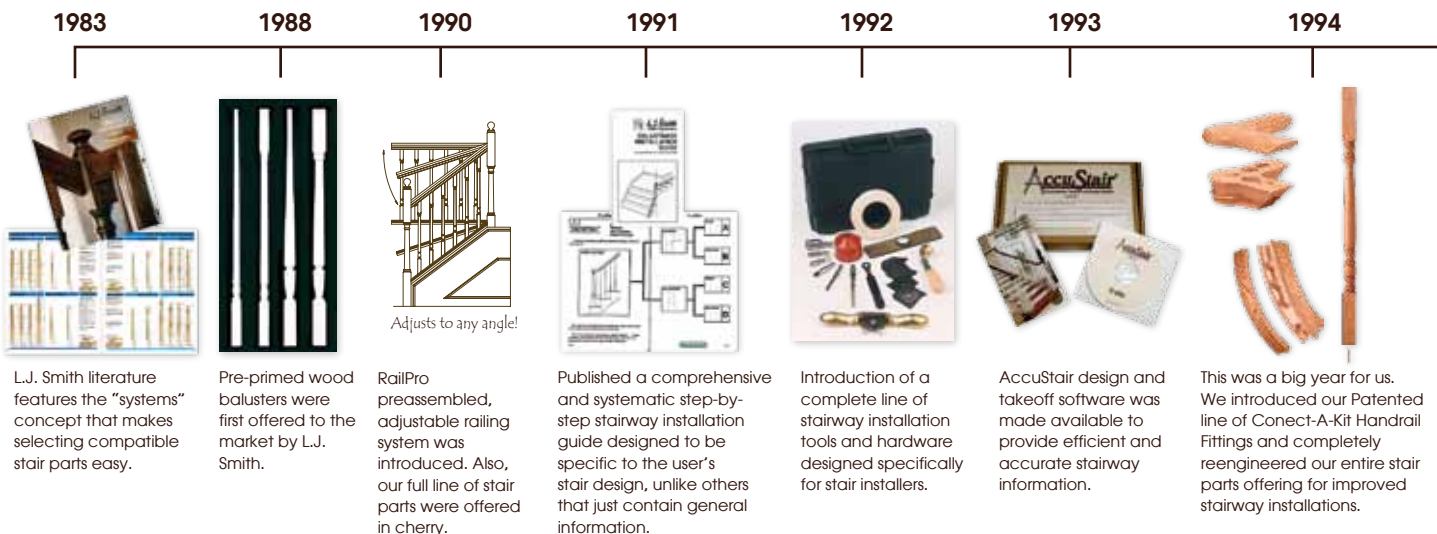

newels for an economical upgrade from plain half wall stairways, stainless steel cable & tube infill systems and many other product enhancements and new designs.

The time line below illustrates the many unique ideas that we've developed into products or marketing tools. Many of these creations were designed to provide stair installers with alternative methods for building stronger stairways. Others were developed to broaden our product offering, providing unlimited design possibilities for any stairway.

Now, look to the pages ahead and see all the care and effort that we take to make the finest quality stairway components, then explore the beautiful choices of style, limited only by your imagination.....

Table of Contents

Why L.J. Smith 3-4

Photo Portfolio 5-10

Steps for Selecting a Beautiful Stair System..... 11-16

Wood Species 17

Stairway Anatomy and Glossary of Stair Terms 17

Post to Post Systems 18-34

Box Newels..... 35-41

Metal Newel Caps 40

Over the Post Systems..... 42-55

Ornamental Iron Collections 56-71

Handrail Fittings 72-78

Starting Steps 79-80

Treads, Risers and Landing Tread..... 80

False Treads and Risers 81

Rosettes 81

Stair Brackets 81

Bending Rails..... 82

Wall Rail and Wall Rail Fittings & Brackets 83

Stairway Installation Tools and Hardware 84-88

Custom Capabilities 89-90

Guidelines for Ordering a Post to Post Stair System (all wood components) 91

Guidelines for Ordering a Post to Post Stair System (with ornamental iron balusters)..... 92

Guidelines for Ordering an Over the Post Stair System (all wood components) 93

Guidelines for Ordering an Over the Post Stair System (with ornamental iron components) 94

Website Information..... 95









Marketing Tools..... 96

Index 97-98

Connect with us!

Join us on social media for the latest news and product releases.



1996	1998	2001	2002-2006	2012	2014	2015	Today
							
Introduced Climbing Volutes to create a sweeping and elegant beginning to over the post stairways.	Added Ornamental Iron Balusters to our product offering.	Began offering a new line of box newels consisting of fluted, raised and recessed panels—designed to match the millwork theme in many homes.	Several more tools designed to make stair installations much quicker.	Introduced a patented iron baluster fastener kit called IronPro for easily remodeling stairs from wood balusters to iron balusters. Also great for new construction.	Patented Half Wall Box Newels to easily upgrade plain half wall stairways.	New modern Linear Collection featuring stainless steel cable and tube infills with predrilled and precut newels.	L.J. Smith furthers its leadership role combining common sense with innovation.

Why L.J. Smith?

L.J. Smith products are defined by their unique design—providing uncompromised durability and good looks. The exclusive features of many of our designs result in unsurpassed strength and the benefits are simply endless.....

Our Handrail Fittings — L.J. Smith offers two types of handrail fittings.

Our “Traditional” fittings utilize rail bolts for installation and our patented line of “Conect-A-Kit®” fittings provide an even better and stronger method for securing handrail fittings to the handrail and to the newel posts. Aside from their common applications, seven of these fittings, used in combination, will make up

26 different Landing Fitting Assemblies (gooseneck fittings).

Conect-A-Kit® unique design also conceals every bit of the installation hardware.

See pages 72-78 for our complete line of Conect-A-Kit® and “Traditional” fittings.

Conect-A-Kit® Fittings



Conect-A-Kit fittings are bolted to the newel posts for a very secure stair system.



Goosenecks are assembled using lag bolts for stronger connections.



The completed assembly reveals no holes, putty or plugs to mar the beauty of the stairway because all of the installation hardware is concealed.

Traditional Fittings



Finish nails are typically used for securing traditional fittings to newel posts. However, we recommend using our Mr. Grip perforated strips.



Traditional gooseneck fittings are assembled with clamp nails.



Utilize clamp nails, rail bolts and wood plugs for installation.

Conect-A-Kit fittings are **Bolted** to the newel posts.

Traditional fittings are secured to the post using our Mr. Grip™ perforated strips

Our Balusters — We offer two types of balusters to suit your installation and aesthetic preferences.

Our “LJ-” Series utilizes a double-end lag screw in the bottom of each baluster. This technique pulls the balusters extremely tight against the surface, producing a very strong railing system....and the hardware is completely concealed. The turning details of these carefully designed balusters flow parallel to the handrail.

The “S-” Series balusters have a turned pin on the bottom for installation and their bottom block detail flows parallel to the treads.

All baluster designs can be found on pages 13-14.

“LJ-” Series Balusters



The double-end lag screw securely tightens down each baluster for a strong rail system. Our Pin E-Z can also be used for installing in the traditional manner.

The hardware is totally concealed so there will be no unsightly marks from installing the balusters.



The turning detail flows with the handrail.

“S-” Series Balusters



The turned wooden pin inserts into drilled holes on the treads and/or landing.

Adhesive and finish nails are typically used for installation to fasten the balusters to the treads.



The detail at the bottom of the baluster flows with the treads.

LJ- Series balusters are **Screwed** down to the treads

S- Series balusters are **glued and nailed** to the treads

Our Newel Posts are **Bolted** to the mounting surface

The choice is yours to experience you're settled into your new or

L.J. Smith is the “one stop shop” for everything needed for your stairway....from our individually crafted component parts to our exclusive offering of innovative tools for installing them. Nowhere will you find a selection that even comes close to the vast array of styles available from L.J. Smith.

Wooden Balusters — If you have a specific design in mind, we’re certain you will find it within the 55 styles we offer. You might decide to move up to one of our heavier styles for an even more dramatic stairway. Below is a sampling of our baluster offering. See pages 13-14 for our array of beaded, fluted, twisted, octagonal styles.

Ornamental Iron Balusters — Generations of fine styling endures in each of our 81 hand forged ornamental balusters. Coupled with the warm touch of a wooden handrail, this timeless combination is as durable as it is beautiful. The bottom of pages 13 & 14 picture the popular styles we offer.



Handrails — Our 30 handrail profiles provide plenty of options from which to choose. Many are also available in bending rail for applications requiring curved hand railing. A glimpse of our handrail profiles can be found on pages 13-14, and our bending rail selections are featured on page 84.



Wooden and Iron Newel Posts — Choose from over 60 perfectly proportioned newel posts of wood or iron. As the “anchors” of your stairway, these are both durable and substantial without any sacrifice of fine design and enduring quality of workmanship. See pages 15-16 for an impressive look at our newel post collection.

the finest, and we’re convinced that, after your L.J. Smith stairway is completed and remodeled home, you will have peace of mind from knowing you made the right choice!

Photo Portfolio



1

1 LIH-MG1KNUC44 & LIH-MG2KNUC44 Iron Balusters, LJRA-4091 Raised Panel Box Newel and LJ-6900 Handrail

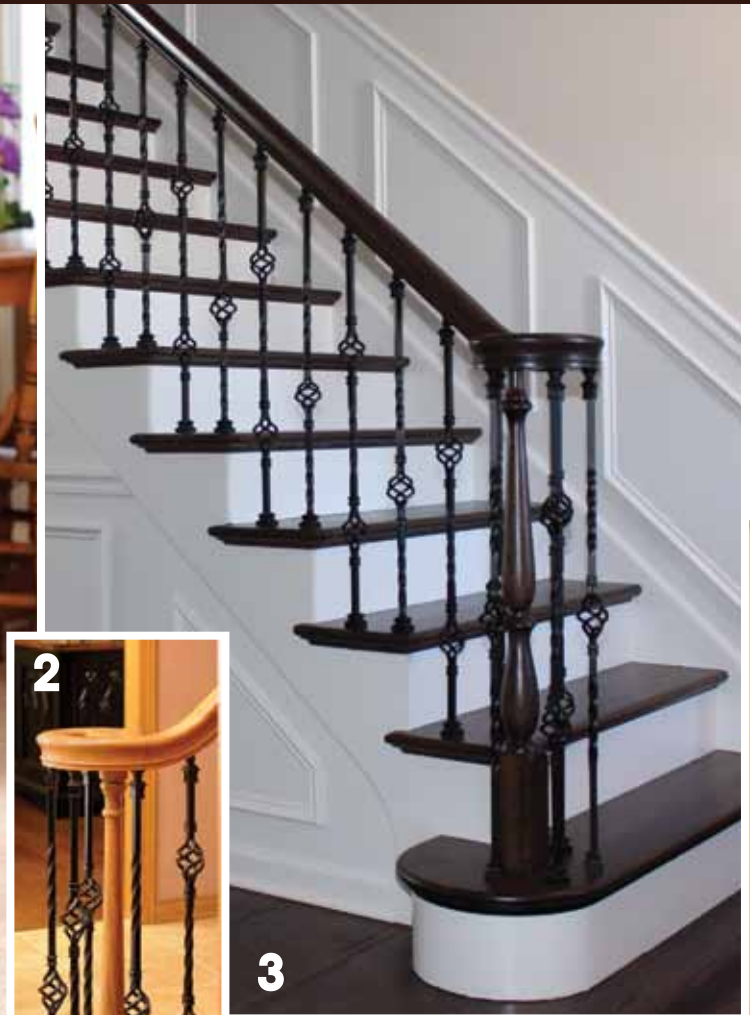

2

3

2 LIH-HOL1BASK44, LIH-HOL2BASK44 Iron Balusters and LI-PROLVL IronPro, LJ-4010 Newel, LJ-6010 Handrail and LJ-7030 Volute

3 LI-1BASK44, LI-2BASK44 Iron Balusters and LI-PROLVL IronPro, Custom Newel, LJ-6010 Handrail and LJ-7030 Volute

4 LIH-HOL1BASK44, LIH-HOLDBLTW44 Iron Balusters and LI-PROLVL IronPro, LJ-4040 Newels and LJ-6010 Handrail



4



5 LI-40144, LI-40244 & LI-WAVE44 Iron Balusters, LI-NWLRIB48 Iron Newels, LJ-6701B Bending Handrail, LJ-7731 & LJ-7736 Custom Climbing Volutes

6 LI-30544 & LI-30844 Iron Balusters, LJ-4091 Box Newels and LJ-6519 Handrail

7 LIH-HOLPLA44 Iron Balusters with LI-ALAK05 Adjustable Knuckles and LI-PROLVL IronPro, LJ-4010 Newel and LJ-6010 Handrail

8 LI-14044, LI-15044, LI-14344 & LI-30144 Iron Balusters, LJF-3010 Newels, LJ-6519B Bending Handrail, LJ-7531 Climbing LJ-8215 Bowed Starting Step



5



6



7



8

Photo Portfolio



1



2

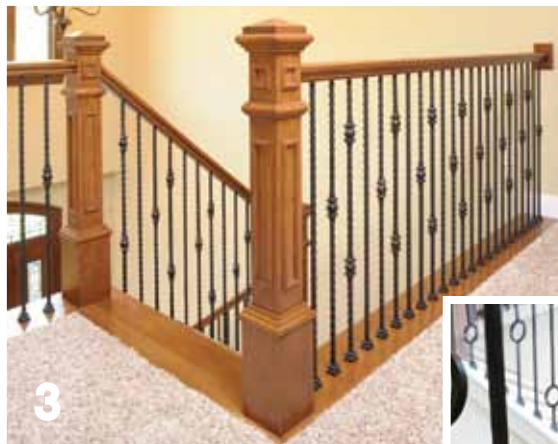

3

1 LIH-HOLPLA44 Iron Balusters with LI-ALAK01 Adjustable Knuckles, LI-ALM06 & LI-ALPSH02 Collars, LJ-4050 Newel, LJ-6010 Handrail and LJ-7030 Volute.

2 LI-1BASK44 & LI-2BASK44 Iron Balusters with LI-PROLVL IronPro, LJ-4040 Newels, LJ-6010 Handrail

3 LI-9044, LI-30544 & LI-30844 Iron Balusters, LJ-4391 Box Newels with LJ-9203 Decorative Picture Frame Kits and LJ-6701 Handrail.

4 LIH-HOL166344 and LIH-HOLPLA44 Iron Balusters, LJ-4095 Box Newels, and LJ-6210 Handrail.

5 LI-40144, LJ-40244 & LI-PLA44 Iron Balusters with LI-ALM06 Shoes



5



4



6





6 LI-30144 & LI-2TW44 Iron Balusters, LJT-3010 Newels, LJ-6400 Handrail with LJ-7430 and LJ-7435 Volutes

7 LIH-KW60144, LIH-KW2TW44 Iron Balusters, LJ-3513PT Newel Post, LJ-6010 Handrail and LJ-7038 Vertical Volute

8 LJ-PLA40BLY Iron Balusters & LJ-6010B Bending Handrail

9 LI-1BASK44, LI-2TW44 & LI-60144 Iron Balusters, LJRA-4091 Box Newels, LJ-6900B Bending Handrail with LJ-7911 Quarterturns and LJ-7912 Upeasings

10 LI-1BASK44, LI-DBLTW44 Iron Balusters, LJT-3010 Newels, LJ-6010 Handrail and LJ-7031 Climbing Volute

11 LIH-HOL30144, LIH-HOLPLA44 Iron Balusters with LI-ALAK02 Adjustable Knuckles, LJ-4010 Newels, Custom Box Newels with Stainable Caps, LJ-6010 Handrail and LJ-7030 & LJ-7035 Volutes.

Photo Portfolio



1 LJC-5360 Balusters, LJ-4094 Box Newels and LJ-6210P Plowed Handrail



2 LJB-2915 Balusters, LJB-3910 Newels, LJ-6900B Bending Handrail and LJ-7936 Climbing Volute

3 LJP-2915 Balusters, LJP-3910 newels, LJ-6900 Handrail, LJ-7930 and LJ-7935 Volutes

4 Custom turned newel and finial

5 LJ-5360 Balusters, LJ-4091 Box Newels, LJ-6400P Plowed Handrail

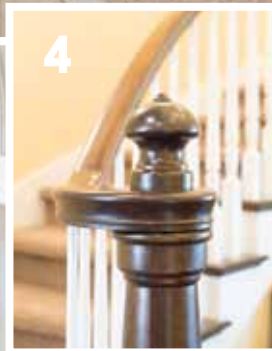



6 LJ-5300 Wood Balusters, LI-1TW44 & LI-50144 Iron Balusters, LJ-4091 Box Newel and 6519 Handrail



8



7 LJP-2115 Balusters, LJ-4094 Recessed Panel Box Newels and LJ-6701 Handrail

8 LJ-2111 Balusters, LJP-3210 Newels, LJ-6A10 handrail.

9 LJ-5360 Balusters, LJ-4095 Raised Panel Box Newels accessorized with LJ-9101 Rosette Blocks and LJ-9001 Chamfered Top Plate, and 6210P Plowed Handrail.

10 LJP-2415 balusters, LJP-3240BT Post to Post Newel, LJP-3210 Over the Post Newel with matching custom pin top newels and custom handrail.



9



10

Four Simple Steps for Selecting a Beautiful

Selecting the component styles for your stairway should be simple, not complicated. L.J. Smith makes this process very easy with these “Four Steps for Selecting a Beautiful Stair System.” As you review these steps, you will notice that we offer a very wide variety of styles from which to choose. Our wood stair parts are available in oak, beech, poplar, maple, hemlock, cherry and we will quote many other species as well. Our wood balusters are also available with a factory primer coating. All stairway components in this catalog are intended for interior use only.

STEP 1 The systems pages of this catalog are divided into two sections to simplify your selection process. To begin, select either the **Post to Post** style or the **Over The Post** style of stairway.

Post to Post Systems

The Handrail runs between the newel posts



Pictured above: LJ-6010 Handrail, LJ-4040 Utility Newels, LI-1BASK44 and LI-2TW44 Iron Balusters.

Post to Post Systems can be found on Pages 18-41

Over the Post Systems

The handrail runs over the newel posts with the use of handrail fittings



Pictured above: LJ-6900 Handrail, LJP-3910 Utility Newels, LJP-3915 Intermediate Landing Newel, LJP-2915 Balusters, LJ-7930 and LJ-7935 Volutes, Landing Fitting Assemblies.

Over the Post Systems can be found on Pages 42-55

STEP 2

After selecting a stairway style, there are a couple more “style” decisions that need to be made before selecting the stairway components. First, decide if the stairway will have Open Treads or a Kneewall and what tread treatment will be utilized. Then, if you chose the **Post to Post** stairway style in step 1, refer to the left bottom side of this page. If you chose the **Over The Post** stairway style see the right bottom half of this page.

Decide if your stairway will have Open Treads or a Kneewall

On an Open Tread Stairway, the balusters are installed directly to the top of the stairway treads. Choose whether or not the steps will be carpeted. If the steps are to be carpeted, then decide if the wood on the treads will be exposed at one or both ends. See pages 80-81 for our available tread products.



Open Tread Stairway



Kneewall Stairway

On a Kneewall Stairway, the balusters are installed into a shoerail and the tread ends are closed or “boxed in”. Decide whether or not the steps will be carpeted. If the steps are to be carpeted, then decide if the carpet runs wall to wall, or if the wood on the treads will be exposed at the ends. See pages 80-81 for our available tread products.

Below are examples of several tread treatments



Kneewall stairway, carpet wall to wall



Open tread stairway, no carpet



Open tread stairway, wood exposed both ends, carpet



Open tread stairway with full treads and open risers

Post to Post Systems

Now determine whether or not the stairway will have landing fitting assemblies at the landings



Landing Fitting Assembly (gooseneck) is used with a short block newel post at all landings.



Handrail runs straight into the top block of the newel post at all landings.

Over the Post Systems

Now select the starting fitting(s) that will be used at the bottom of the stairway*



Climbing Volute
Requires a Starting Step



Volute
Requires a Starting Step



Turnout
Requires a Starting Step



Vertical Volute
Does not require a Starting Step



Starting Easing with Cap
Does not require a Starting Step

*NOTE: If a Kneewall style stairway was selected above, then a Vertical Volute or Starting Easing with Cap should be selected here.

Four Simple Steps for Selecting a Beautiful

STEP 3 Select a **BALUSTER**. When selecting a wood baluster style, you can choose either a Pin Top or a Square Top Style. To the right are photos showing both styles. After deciding which "look" you prefer, make your selection from the wood balusters below. If you prefer iron balusters, make your selection from the Ornamental Iron balusters at the bottom of these two pages.

STEP 4 Select a **HANDRAIL**. The corresponding handrails are shown above the balusters with which they can be used.



1 3/4" PIN TOP BALUSTERS



Harbor Collection Pages: 19, 43
Briarcliffe Collection Pages: 21, 45
Regent Collection Pages: 25, 49
Harmony Collection Pages: 27, 51
Colony Collection Page: 30
Clean Collection See Page 33 for compatible handrails

1 1/4" PIN TOP BALUSTERS



LaSalle Collection Pages: 23, 47
Classic Collection Pages: 29, 55
Cornerstone Collection Pages: 31, 53
Crisp Collection Page: 34

All balusters below can be used with any of our Non-Plowed Handrails

ORNAMENTAL IRON BALUSTERS



Horizon Collection Pages: 57, 58, 67
Ribbon Collection Page: 59
Hoop Collection Page: 60
Finesse Collection Page: 61, 67



Pin Top Balusters are used with Flat Bottom (non-plowed) Handrails



Square Top Balusters are used with Plowed Handrails

PLOWED HANDRAILS

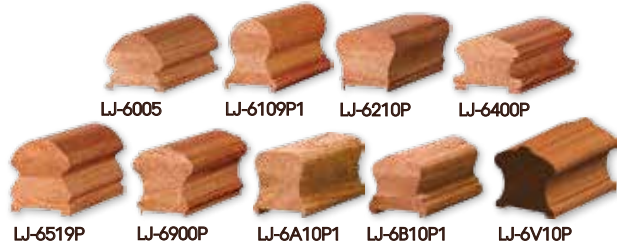

LJ-6005

LJ-6109P1

LJ-6210P

LJ-6400P

LJ-6519P

LJ-6900P

LJ-6A10P1

LJ-6B10P1

LJ-6V10P

1 3/4" SQUARE TOP BALUSTERS



Harbor Collection

Pages: 19, 43

Briarcliffe Collection

Pages: 21, 45

Regent Collection

Pages: 25, 49

Harmony Collection

Pages: 27, 51

Colony Collection

Page: 30

PLOWED HANDRAILS



LJ-6010P

LJ-6000



LJ-6109P0

LJ-6601P



LJ-6A10P0

LJ-6B10P0

1 1/4" SQUARE TOP BALUSTERS



LaSalle Collection

Pages: 23, 47

Classic Collection

Pages: 29, 55

Cornerstone Collection

Pages: 31, 53

NON-PLOWED HANDRAILS AND PLOWED HANDRAILS



LJ-6000

LJ-6001



LJ-6003

LJ-6203

1 1/4" SQUARE BALUSTERS



Clean Collection

Page: 33

Crisp Collection

Page: 34

More styles available on pages 33-34

All balusters below can be used with any of our Non-Plowed Handrails

ORNAMENTAL IRON BALUSTERS



Contempo Collection

Page: 62

Pummel Collection

Page: 63

Feather Collection

Page: 63

Honeycomb Collection

Page: 64

Camelot Collection

Page: 65

Espresso Collection

Page: 66

Orb Collection

Page: 66

Four Simple Steps for Selecting a Beautiful

On these two pages you will find our vast array of newel post styles. While being sure to look at the top row for a **Post to Post** stair or the bottom row for an **Over The Post** stair, find the newel post style which matches your chosen baluster.

POST TO POST STYLES



Harbor Collection
Page: 20



Briarcliffe Collection
Page: 22



LaSalle Collection
Page: 24



Regent Collection
Page: 26



Harmony Collection
Page: 28



Classic Collection
Page: 29



Colony Collection
Page: 30

OVER THE POST STYLES



Harbor Collection
Page: 44



Briarcliffe Collection
Page: 46



LaSalle Collection
Page: 48



Regent Collection
Page: 50

You can then refer to the page listed below the selected newel to see the complete system. **Post to Post** systems can be found on pages 19 to 41 and **Over The Post** systems can be found on pages 43 to 55.

POST TO POST STYLES



Many more styles of Box Newels are available on pages 36-41

OVER THE POST STYLES



Our Wood Species

L.J. Smith is proud to offer the following standard species of wood products. Material in all of these species is in stock and can be made into nearly any of our wood stair components. We would also be glad to quote any other species, as well. Call us for product availability and lead times on these, and other species.

Note: all species shown here are clear coated for illustrative purposes only.

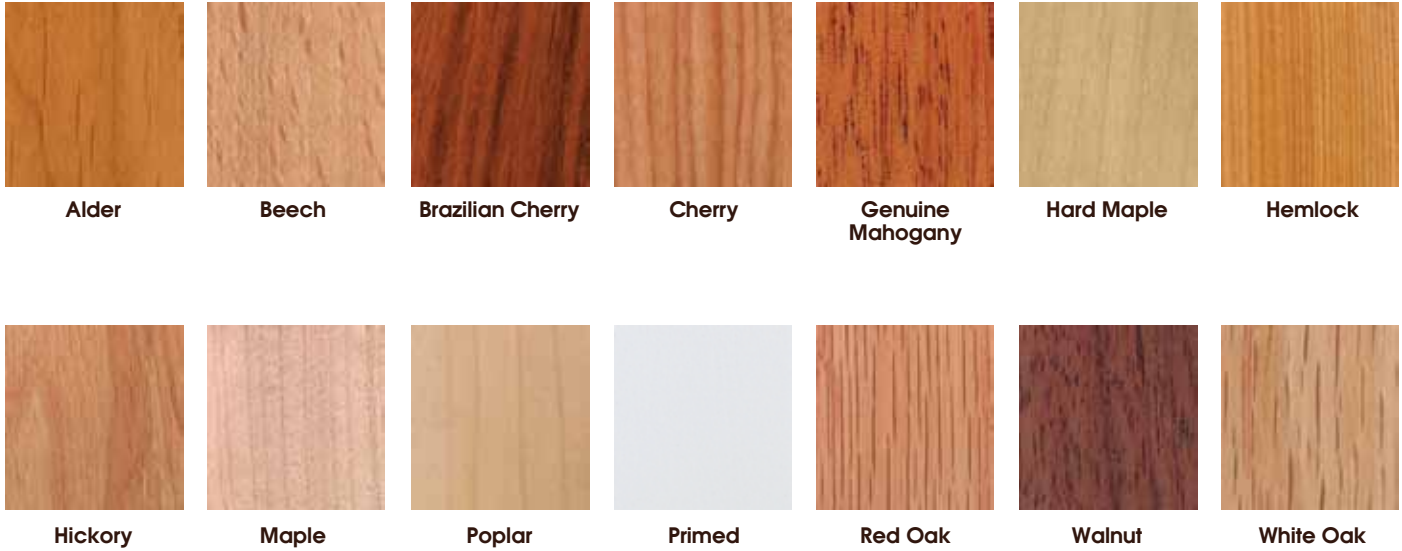

Anatomy of a Post to Post System

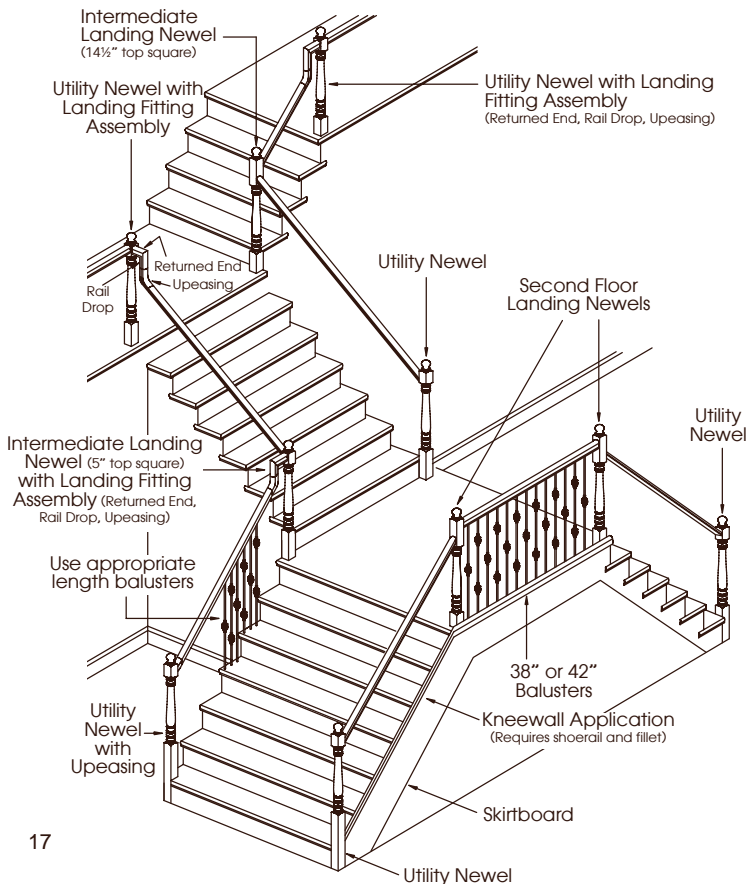

Anatomy of an Over the Post System

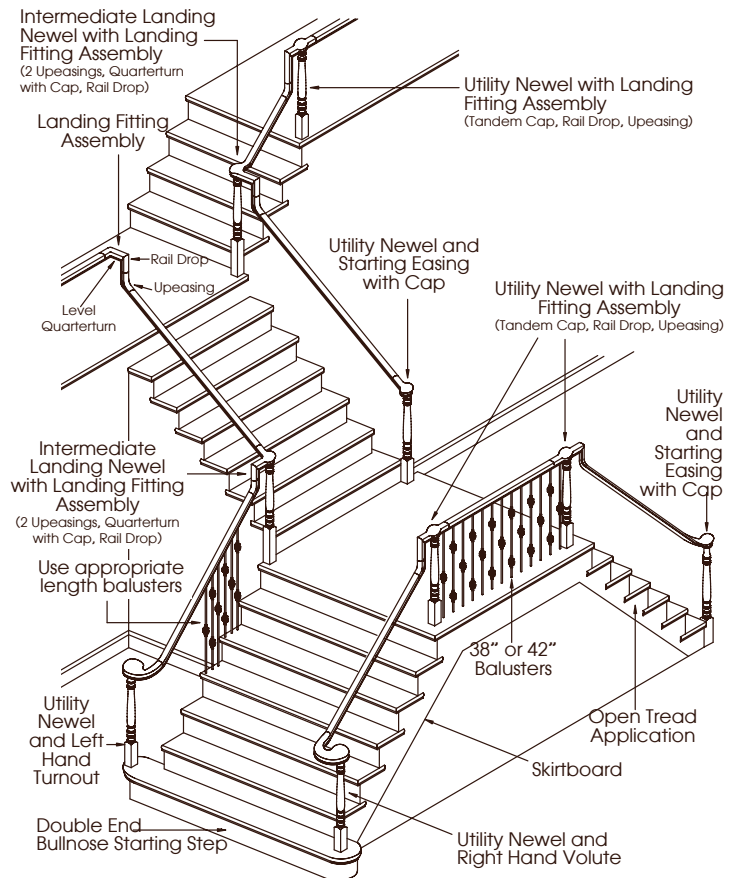

Post to Post Systems

This section features all of our wood Post to Post Balustrade options. Each collection pictures components that are compatible with one another. We recommend choosing the handrail, baluster and newel styles for your stairway from the same collection.

Post to Post

Pictured: LJ-6010 Handrail, LJ-6010B Bending Handrail, S-5015 Balusters, and LJ-4180 Newel Series.

Non-Plowed Handrails and Pin Top Balusters



2915 balusters can be used with LJ-6109, LJ-6210, LJ-6400, LJ-6519, LJ-6701, LJ-6900, LJ-6A10 or LJ-6B10 handrails.

Plowed Handrails and Square Top Balusters

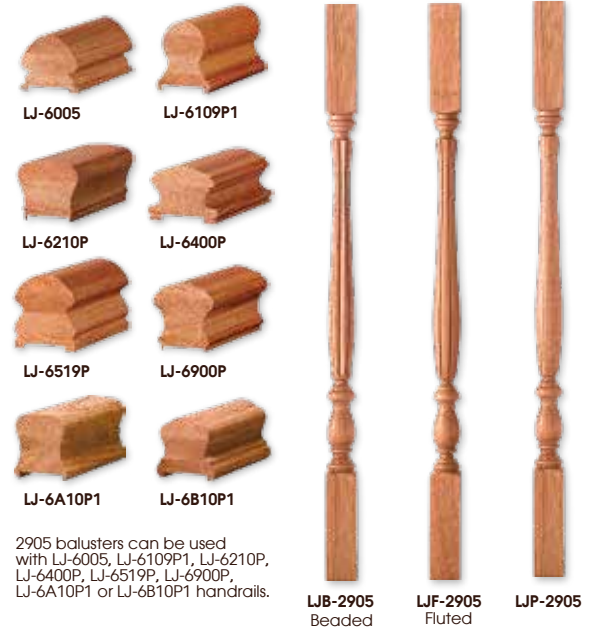

2905 balusters can be used with LJ-6005, LJ-6109P1, LJ-6210P, LJ-6400P, LJ-6519P, LJ-6900P, LJ-6A10P1 or LJ-6B10P1 handrails.

Shoerail & Fillet



Balusters on this page are pre-drilled with a 9/32" (7 mm) diameter hole at least 3" (76 mm) deep in which a pin ("Pin E-Z") is loosely inserted. Every baluster can then be installed in the traditional manner, or by using the Dowel-Fast™ screws as shown on page 85 (sold separately).

Product Dimensions

Handrails:	Height	Profile Width	Bottom Width	Plow Width
LJ-6005	2 3/8" (59 mm)	2 1/2" (64 mm)	2 1/2" (64 mm)	1 3/4" (44 mm)
LJ-6109	2 1/8" (73 mm)	1 1/4" (48 mm)	2 3/8" (60 mm)	N/A
LJ-6109P1	2 1/8" (73 mm)	1 1/8" (48 mm)	2 3/8" (60 mm)	1 3/4" (44 mm)
LJ-6210	2 3/8" (60 mm)	2 3/8" (67 mm)	2" (51 mm)	N/A
LJ-6210P	2 3/8" (60 mm)	2 3/8" (67 mm)	2" (51 mm)	1 3/4" (44 mm)
LJ-6400	2 1/4" (67 mm)	2 3/4" (70 mm)	3" (76 mm)	N/A
LJ-6400P	2 1/4" (67 mm)	2 3/4" (70 mm)	3" (76 mm)	1 3/4" (44 mm)
LJ-6519	3" (76 mm)	2 5/8" (67 mm)	2 5/8" (67 mm)	N/A
LJ-6519P	3" (76 mm)	2 5/8" (67 mm)	2 5/8" (67 mm)	1 3/4" (44 mm)
LJ-6701	2 1/4" (64 mm)	2 3/4" (70 mm)	1 9/8" (41 mm)	N/A
LJ-6900	2 3/4" (70 mm)	2 5/8" (67 mm)	1 13/16" (49 mm)	N/A
LJ-6900P	2 3/4" (70 mm)	2 5/8" (67 mm)	1 13/16" (49 mm)	1 3/4" (44 mm)
LJ-6A10	2 3/8" (60 mm)	2" (51 mm)	2 1/8" (54 mm)	N/A
LJ-6A10P1	2 3/8" (60 mm)	2" (51 mm)	2 1/8" (54 mm)	1 3/4" (44 mm)
LJ-6B10	2 3/8" (60 mm)	2" (51 mm)	2 3/8" (60 mm)	N/A
LJ-6B10P1	2 3/8" (60 mm)	2" (51 mm)	2 3/8" (60 mm)	1 3/4" (44 mm)

Shoerail and Fillet:	Height	Width	Plow Width
LJ-6006	1" (25 mm)	3 1/8" (79 mm)	1 3/4" (44 mm)
LJ-6007	3/4" (8 mm)	1 3/4" (44 mm)	N/A

Balusters:	Top Block	Turning Length	Bottom Block	Square Size	Overall Length
2905-34	6 1/4" (165 mm)	21 1/4" (535 mm)	6 7/8" (164 mm)	1 3/4" (44 mm)	34" (864 mm)
2905-38	6 1/2" (165 mm)	21 1/4" (535 mm)	10 7/8" (265 mm)	1 3/4" (44 mm)	38" (965 mm)
2905-42	6 1/2" (165 mm)	21 1/4" (535 mm)	14 7/8" (367 mm)	1 3/4" (44 mm)	42" (1067 mm)
2915-34	N/A	27 9/16" (700 mm)	6 7/8" (164 mm)	1 3/4" (44 mm)	34" (864 mm)
2915-38	N/A	27 9/16" (700 mm)	10 7/8" (265 mm)	1 3/4" (44 mm)	38" (965 mm)
2915-42	N/A	27 9/16" (700 mm)	14 7/8" (367 mm)	1 3/4" (44 mm)	42" (1067 mm)

Newel Posts:	Finial	Top Block	Turning Length	Bottom Block	Square Size	Overall Length
Utility Newels						
3940	5 7/8" (138 mm)	5" (127 mm)	23 1/4" (586 mm)	14 1/4" (362 mm)	3 1/4" (83 mm)	48" (1219 mm)
3942	5 7/8" (138 mm)	5" (127 mm)	23 1/4" (586 mm)	24 1/4" (616 mm)	3 1/4" (83 mm)	58" (1473 mm)
Second Floor Landing Newel						
3945	5 7/8" (138 mm)	11" (279 mm)	19 1/2" (495 mm)	21 3/4" (552 mm)	3 1/4" (83 mm)	58" (1473 mm)
Intermediate Landing Newels						
3946	5 7/8" (138 mm)	14 1/2" (368 mm)	16" (406 mm)	36 3/4" (933 mm)	3 1/4" (83 mm)	73" (1854 mm)
3958	5 7/8" (138 mm)	5" (127 mm)	23 1/4" (586 mm)	44 1/4" (1124 mm)	3 1/4" (83 mm)	78" (1981 mm)

* Length is from the top of the bottom block to the top of the baluster



Newel Posts

Newel Drop



LJ-4099A



LJB-3940
LJB-3942
LJB-3958†

LJB-3945

LJB-3946

LJF-3940
LJF-3942
LJF-3958†

LJF-3945

LJF-3946

LJP-3940
LJP-3942
LJP-3958†

LJP-3945

LJP-3946

Box Newels

Beaded Option

Fluted Option

Consider box newels for your stairway from our Hierloom Collection on pages 36-41

† Requires a landing fitting assembly (gooseneck pp 77-78)



Pictured Above: LJ-6900 Handrail, Custom Box Newels and LJP-2915 Balusters.



Pictured Right: LJ-6519 Handrail, LJB-3940 Utility Newels, LJB-2915 Balusters.

Non-Plowed Handrails and Pin Top Balusters

Plowed Handrails and Square Top Balusters



2115 and LJP-2111 balusters can be used with LJ-6109, LJ-6210, LJ-6400, LJ-6519, LJ-6701, LJ-6900, LJ-6A10 or LJ-6B10 handrails.

Shoerail & Fillet



2105 balusters can be used with LJ-6005, LJ-6109P1, LJ-6210P, LJ-6400P, LJ-6519P, LJ-6900P, LJ-6A10P1 or LJ-6B10P1 handrails.

Balusters on this page are pre-drilled with a 9/32" (7 mm) diameter hole at least 3" (76 mm) deep in which a pin ("Pin E-Z") is loosely inserted. Every baluster can then be installed in the traditional manner, or by using the Dowel-Fast™ screws as shown on page 85 (sold separately).

Product Dimensions

Handrails:	Height	Profile Width	Bottom Width	Plow Width
LJ-6005	2 3/4" (69 mm)	2 1/2" (64 mm)	2 1/2" (64 mm)	1 3/4" (44 mm)
LJ-6109	2 3/8" (73 mm)	1 3/4" (48 mm)	2 3/8" (60 mm)	N/A
LJ-6109P1	2 3/8" (73 mm)	1 3/8" (48 mm)	2 3/8" (60 mm)	1 3/4" (44 mm)
LJ-6210	2 3/8" (60 mm)	2 3/8" (67 mm)	2" (51 mm)	N/A
LJ-6210P	2 3/8" (60 mm)	2 3/8" (67 mm)	2" (51 mm)	1 3/4" (44 mm)
LJ-6400	2 1/4" (57 mm)	2 3/4" (70 mm)	3" (76 mm)	N/A
LJ-6400P	2 1/4" (57 mm)	2 3/4" (70 mm)	3" (76 mm)	1 3/4" (44 mm)
LJ-6519	3" (76 mm)	2 3/8" (67 mm)	2 3/8" (67 mm)	N/A
LJ-6519P	3" (76 mm)	2 3/8" (67 mm)	2 3/8" (67 mm)	1 3/4" (44 mm)
LJ-6701	2 1/4" (54 mm)	2 3/4" (70 mm)	1 3/4" (41 mm)	N/A
LJ-6900	2 3/4" (70 mm)	2 3/4" (67 mm)	1 13/16" (49 mm)	N/A
LJ-6900P	2 3/4" (70 mm)	2 3/4" (67 mm)	1 13/16" (49 mm)	1 3/4" (44 mm)
LJ-6A10	2 3/8" (60 mm)	2" (51 mm)	2 3/8" (54 mm)	N/A
LJ-6A10P1	2 3/8" (60 mm)	2" (51 mm)	2 3/8" (54 mm)	1 3/4" (44 mm)
LJ-6B10	2 3/8" (59 mm)	2" (51 mm)	2 3/8" (60 mm)	N/A
LJ-6B10P1	2 3/8" (59 mm)	2" (51 mm)	2 3/8" (60 mm)	1 3/4" (44 mm)

Shoerail and Fillet:	Height	Width	Plow Width
LJ-6006	1" (25 mm)	3 3/8" (99 mm)	1 3/4" (44 mm)
LJ-6007	3/4" (8 mm)	1 3/4" (44 mm)	N/A

Balusters:	Top Block	Turning Length	Bottom Block	Square Size	Overall Length
2105-34	6 1/2" (165 mm)	19 1/2" (496 mm)	8 3/8" (213 mm)	1 3/4" (44 mm)	34" (864 mm)
2105-38	6 1/2" (165 mm)	19 1/2" (496 mm)	12 3/8" (314 mm)	1 3/4" (44 mm)	38" (965 mm)
2105-42	6 1/2" (165 mm)	19 1/2" (496 mm)	16 3/8" (416 mm)	1 3/4" (44 mm)	42" (1067 mm)
2111-34	N/A	25 3/8" (651 mm)	8 3/8" (213 mm)	1 3/4" (44 mm)	34" (864 mm)
2111-38	N/A	25 3/8" (651 mm)	12 3/8" (314 mm)	1 3/4" (44 mm)	38" (965 mm)
2111-42	N/A	25 3/8" (651 mm)	16 3/8" (416 mm)	1 3/4" (44 mm)	42" (1067 mm)
2115-34	N/A	25 7/16" (642 mm)	8 7/16" (214 mm)	1 3/4" (44 mm)	34" (864 mm)
2115-38	N/A	25 7/16" (642 mm)	12 7/16" (316 mm)	1 3/4" (44 mm)	38" (965 mm)
2115-42	N/A	25 7/16" (642 mm)	16 7/16" (418 mm)	1 3/4" (44 mm)	42" (1067 mm)

Newel Posts:	Finial	Top Block	Turning Length	Bottom Block	Square Size	Overall Length
Utility Newels						
3340	5" (127 mm)	5" (127 mm)	23" (584 mm)	1 1/2" (38 mm)	3 1/2" (89 mm)	48" (1219 mm)
3342	5" (127 mm)	5" (127 mm)	23" (584 mm)	2 1/4" (62 mm)	3 1/2" (89 mm)	58" (1473 mm)
Second Floor Landing Newel						
3345	5" (127 mm)	11" (279 mm)	19 1/2" (495 mm)	22" (558 mm)	3 1/2" (89 mm)	58" (1473 mm)
Intermediate Landing Newels						
3346	5" (127 mm)	14 1/2" (368 mm)	16 3/4" (419 mm)	36 1/2" (927 mm)	3 1/2" (89 mm)	73" (1854 mm)
3358	5" (127 mm)	5" (127 mm)	23" (584 mm)	44 1/2" (1130 mm)	3 1/2" (89 mm)	78" (1981 mm)

* Length is from the top of the bottom block to the top of the baluster



Newel Posts



Available in Ball Top
Specify "BT" suffix
(LJF-3340BT)
(LJP-3340BT)

Newel Drop



LJ-4299A



LJP-3340
LJF-3342
LJF-3358†



LJP-3345



LJP-3346

Fluted Option



LJP-3340
LJP-3342
LJP-3358†



LJP-3345



LJP-3346

Consider box newels for your stairway from our Hierloom Collection on pages 36-41

Box Newels

† Requires a landing fitting assembly (gooseneck pp 77-78)

Pictured Left: LJ-6519P Handrail, LJP-3340BT Newels and LJP-2105 Balusters.

Pictured Below: LJP-2111 Balusters.

Pictured Right: LJ-6210B Bending Handrail and LJ-2111 Balusters.



Non-Plowed Handrails and Pin Top Balusters



LJ-6002 LJ-6010



LJ-6109 LJ-6601



LJ-6A10 LJ-6B10



LJ-2415 LJ-2011

LJP-2415 and LJ-2011 balusters can be used with LJ-6002, LJ-6010, LJ-6109, LJ-6601, LJ-6A10 or LJ-6B10 handrails.

Plowed Handrails and Square Top Balusters



LJ-6000 LJ-6010P



LJ-6109P0 LJ-6601P

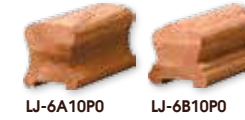

LJ-6A10P0 LJ-6B10P0



LJP-2405

Shoerail & Fillet



LJ-6050

LJ-6045

LJP-2405 balusters can be used with LJ-6000, LJ-6010P, LJ-6109P0, LJ-6601P, LJ-6A10P0 or LJ-6B10P0 handrails.

Balusters on this page are pre-drilled with a 9/32" (7 mm) diameter hole at least 3" (76 mm) deep in which a pin ("Pin E-Z") is loosely inserted. Every baluster can then be installed in the traditional manner, or by using the Dowel-Fast™ screws as shown on page 85 (sold separately).

Product Dimensions

Handrails:	Height	Profile Width	Bottom Width	Plow Width
LJ-6000	1 3/8" (41 mm)	2 3/4" (70 mm)	2 3/4" (70 mm)	1 1/4" (32 mm)
LJ-6002	1 3/8" (41 mm)	2 3/4" (70 mm)	2 3/4" (70 mm)	N/A
LJ-6010	2 3/4" (60 mm)	2 1/4" (57 mm)	1 1/2" (38 mm)	N/A
LJ-6010P	2 3/8" (60 mm)	2 1/4" (57 mm)	1 1/2" (38 mm)	1 1/4" (32 mm)
LJ-6109	2 7/8" (73 mm)	1 3/8" (48 mm)	2 3/8" (60 mm)	N/A
LJ-6109P0	2 7/8" (73 mm)	1 3/8" (48 mm)	2 3/8" (60 mm)	1 1/4" (32 mm)
LJ-6601	2 1/4" (57 mm)	2 1/4" (57 mm)	1 1/2" (38 mm)	N/A
LJ-6601P	2 1/4" (57 mm)	2 1/4" (57 mm)	1 1/2" (38 mm)	1 1/4" (32 mm)
LJ-6A10	2 3/8" (60 mm)	2" (51 mm)	2 3/8" (60 mm)	N/A
LJ-6A10P0	2 3/8" (60 mm)	2" (51 mm)	2 3/8" (60 mm)	1 1/4" (32 mm)
LJ-6B10	2 3/8" (59 mm)	2" (51 mm)	2 3/8" (60 mm)	N/A
LJ-6B10P0	2 3/8" (59 mm)	2" (51 mm)	2 3/8" (60 mm)	1 1/4" (32 mm)

Shoerail and Fillet:	Height	Width	Plow Width
LJ-6045	3/4" (19 mm)	2 1/2" (64 mm)	1 1/4" (32 mm)
LJ-6050	3/8" (10 mm)	1 1/4" (32 mm)	N/A

Balusters:	Top Block	Turning Length	Bottom Block	Square Size	Overall Length
2011-34	N/A	25 9/16" (642 mm)	8 7/16" (214 mm)	1 1/4" (32 mm)	34" (864 mm)
2011-38	N/A	25 9/16" (642 mm)	12 7/16" (316 mm)	1 1/4" (32 mm)	38" (965 mm)
2011-42	N/A	25 9/16" (642 mm)	16 7/16" (418 mm)	1 1/4" (32 mm)	42" (1067 mm)
2405-34	6 9/16" (167 mm)	19 1/16" (484 mm)	8 3/8" (213 mm)	1 1/4" (32 mm)	34" (864 mm)
2405-38	6 9/16" (167 mm)	19 1/16" (484 mm)	12 3/8" (314 mm)	1 1/4" (32 mm)	38" (965 mm)
2405-42	6 9/16" (167 mm)	19 1/16" (484 mm)	16 3/8" (416 mm)	1 1/4" (32 mm)	42" (1067 mm)
2415-34	N/A	25 1/2" (648 mm)	8 1/2" (216 mm)	1 1/4" (32 mm)	34" (864 mm)
2415-38	N/A	25 1/2" (648 mm)	12 1/2" (318 mm)	1 1/4" (32 mm)	38" (965 mm)
2415-42	N/A	25 1/2" (648 mm)	16 1/2" (419 mm)	1 1/4" (32 mm)	42" (1067 mm)

Newel Posts:	Finial	Top Block	Turning Length	Bottom Block	Square Size	Overall Length
--------------	--------	-----------	----------------	--------------	-------------	----------------

Utility Newels						
3240	5" (127 mm)	5" (127 mm)	23" (584 mm)	1 1/2" (38 mm)	3" (76 mm)	48" (1219 mm)
3242	5" (127 mm)	5" (127 mm)	23" (584 mm)	2 1/4" (62 mm)	3" (76 mm)	58" (1473 mm)

Second Floor Landing Newel						
3245	5" (127 mm)	11" (279 mm)	19 1/2" (495 mm)	22" (558 mm)	3" (76 mm)	58" (1473 mm)

Intermediate Landing Newels						
3246	5" (127 mm)	14 1/2" (368 mm)	16 1/2" (419 mm)	36 1/2" (927 mm)	3" (76 mm)	73" (1854 mm)
3258	5" (127 mm)	5" (127 mm)	23" (584 mm)	44 1/2" (1130 mm)	3" (76 mm)	78" (1981 mm)

* Length is from the top of the bottom block to the top of the baluster



Pictured Below: LJ-6B10 Handrail and LJ-2115 Balusters.

Pictured Right: LJ-2011 Balusters.

Pictured Far Right: LJ-6519P Handrail, LJF-3240 Series Newels and LJF-2105 Balusters.

Newel Posts



Available in Ball Top
Specify "BT" suffix
(LJF-3240BT)
(LJP-3240BT)

Newel Drop



LJ-4099A



LJF-3240
LJF-3242
LJF-3258†



LJF-3245



LJF-3246

Fluted Option



LJP-3240
LJP-3242
LJP-3258†



LJP-3245



LJP-3246

Consider box newels for your stairway from our Hierloom Collection on pages 36-41

Box Newels

† Requires a landing fitting assembly (gooseneck pp 77-78)



Non-Plowed Handrails and Pin Top Balusters

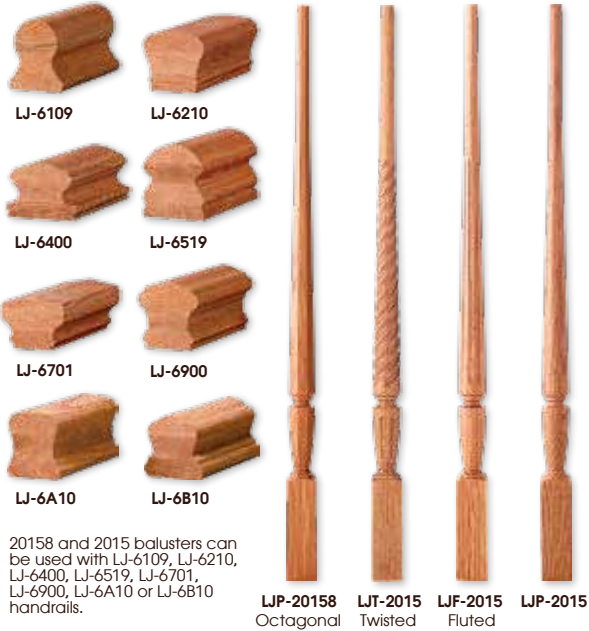

20158 and 2015 balusters can be used with LJ-6109, LJ-6210, LJ-6400, LJ-6519, LJ-6701, LJ-6900, LJ-6A10 or LJ-6B10 handrails.

Plowed Handrails and Square Top Balusters

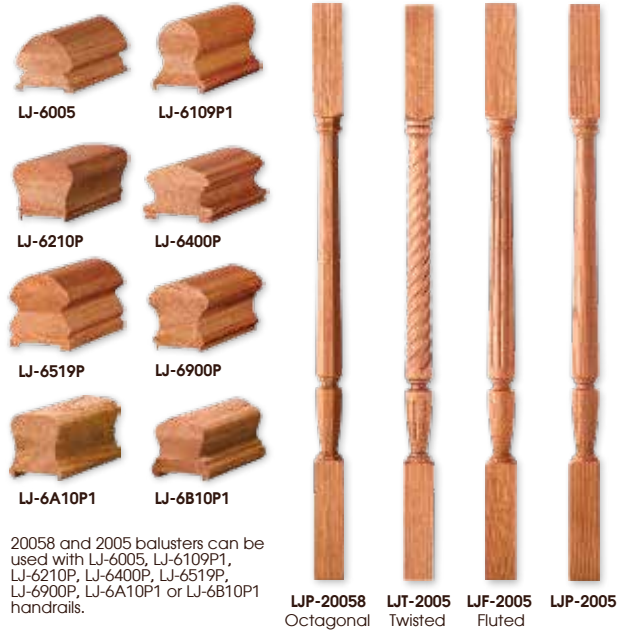

20058 and 2005 balusters can be used with LJ-6005, LJ-6109P1, LJ-6210P, LJ-6400P, LJ-6519P, LJ-6900P, LJ-6A10P1 or LJ-6B10P1 handrails.

Shoerail & Fillet



Balusters on this page are pre-drilled with a 9/32" (7 mm) diameter hole at least 3" (76 mm) deep in which a pin ("Pin E-Z") is loosely inserted. Every baluster can then be installed in the traditional manner, or by using the Dowel-Fast™ screws as shown on page 85 (sold separately).

Product Dimensions

Handrails:	Height	Profile Width	Bottom Width	Plow Width
LJ-6005	2 5/8" (59 mm)	2 1/2" (64 mm)	2 1/2" (64 mm)	1 3/4" (44 mm)
LJ-6109	2 1/4" (73 mm)	1 1/4" (48 mm)	2 3/4" (60 mm)	N/A
LJ-6109P1	2 1/8" (73 mm)	1 1/4" (48 mm)	2 3/4" (60 mm)	1 3/4" (44 mm)
LJ-6210	2 3/4" (60 mm)	2 3/4" (67 mm)	2" (51 mm)	N/A
LJ-6210P	2 3/4" (60 mm)	2 3/4" (67 mm)	2" (51 mm)	1 3/4" (44 mm)
LJ-6400	2 1/4" (57 mm)	2 3/4" (70 mm)	3" (76 mm)	N/A
LJ-6400P	2 1/4" (57 mm)	2 3/4" (70 mm)	3" (76 mm)	1 3/4" (44 mm)
LJ-6519	3" (76 mm)	2 3/4" (67 mm)	2 3/4" (67 mm)	N/A
LJ-6519P	3" (76 mm)	2 3/4" (67 mm)	2 3/4" (67 mm)	1 3/4" (44 mm)
LJ-6701	2 1/4" (54 mm)	2 3/4" (70 mm)	1 3/4" (41 mm)	N/A
LJ-6900	2 3/4" (70 mm)	2 3/4" (67 mm)	1 9/16" (49 mm)	N/A
LJ-6900P	2 3/4" (70 mm)	2 3/4" (67 mm)	1 9/16" (49 mm)	1 3/4" (44 mm)
LJ-6A10	2 3/4" (60 mm)	2" (51 mm)	2 1/4" (54 mm)	N/A
LJ-6A10P1	2 3/4" (60 mm)	2" (51 mm)	2 1/4" (54 mm)	1 3/4" (44 mm)
LJ-6B10	2 3/4" (59 mm)	2" (51 mm)	2 3/4" (60 mm)	N/A
LJ-6B10P1	2 3/4" (59 mm)	2" (51 mm)	2 3/4" (60 mm)	1 3/4" (44 mm)

Shoerail and Fillet:	Height	Width	Plow Width
LJ-6006	1" (25 mm)	3 1/4" (79 mm)	1 3/4" (44 mm)
LJ-6007	5/8" (8 mm)	1 3/4" (44 mm)	N/A

Balusters:	Top Block	Turning Length	Bottom Block	Square Size	Overall Length
2005(8)-34	7" (178 mm)	20" (508 mm)	7" (178 mm)	1 3/4" (44 mm)	34" (864 mm)
2005(8)-38	7" (178 mm)	20" (508 mm)	11" (279 mm)	1 3/4" (44 mm)	38" (965 mm)
2005(8)-42	7" (178 mm)	20" (508 mm)	15" (381 mm)	1 3/4" (44 mm)	42" (1067 mm)
2015(8)-34	N/A	28" (711 mm)	6" (152 mm)	1 3/4" (44 mm)	34" (864 mm)
2015(8)-38	N/A	28" (711 mm)	10" (254 mm)	1 3/4" (44 mm)	38" (965 mm)
2015(8)-42	N/A	28" (711 mm)	14" (356 mm)	1 3/4" (44 mm)	42" (1067 mm)

Newel Posts:	Finial	Top Block	Turning Length	Bottom Block	Square Size	Overall Length
Utility Newels						
3040(8)	4 3/4" (121 mm)	5" (127 mm)	23" (584 mm)	15" (381 mm)	3 1/2" (89 mm)	48" (1219 mm)
3042(8)	4 3/4" (121 mm)	5" (127 mm)	23" (584 mm)	25" (635 mm)	3 1/2" (89 mm)	58" (1473 mm)
Second Floor Landing Newel						
3045(8)	4 3/4" (121 mm)	11" (279 mm)	19 1/2" (495 mm)	22" (558 mm)	3 1/2" (89 mm)	58" (1473 mm)
Intermediate Landing Newels						
3046(8)	4 3/4" (121 mm)	14 1/2" (368 mm)	16" (406 mm)	37" (939 mm)	3 1/2" (89 mm)	73" (1854 mm)
3058(8)	4 3/4" (121 mm)	5" (127 mm)	23" (584 mm)	45" (1143 mm)	3 1/2" (89 mm)	78" (1981 mm)

* Length is from the top of the bottom block to the top of the baluster



Newel Posts

Newel Drop



LJ-4299A



LJP-30408
LJP-30428
LJP-30588†

LJP-30458 LJP-30468
Octagonal Option

LJT-3040
LJT-3042
LJT-3058†

LJT-3045 LJT-3046
Twisted Option

LJF-3040
LJF-3042
LJF-3058†

LJF-3045 LJF-3046
Fluted Option

LJP-3040
LJP-3042
LJP-3058†

LJP-3045 LJP-3046
Box Newels

Consider box newels for your stairway from our Hiefloor Collection on pages 36-41

† Requires a landing fitting assembly (gooseneck pp 77-78)



Pictured: LJP-2015 Balusters.

Pictured Right: Custom Bending Handrail, LJP-2015 Balusters, Custom Treads.

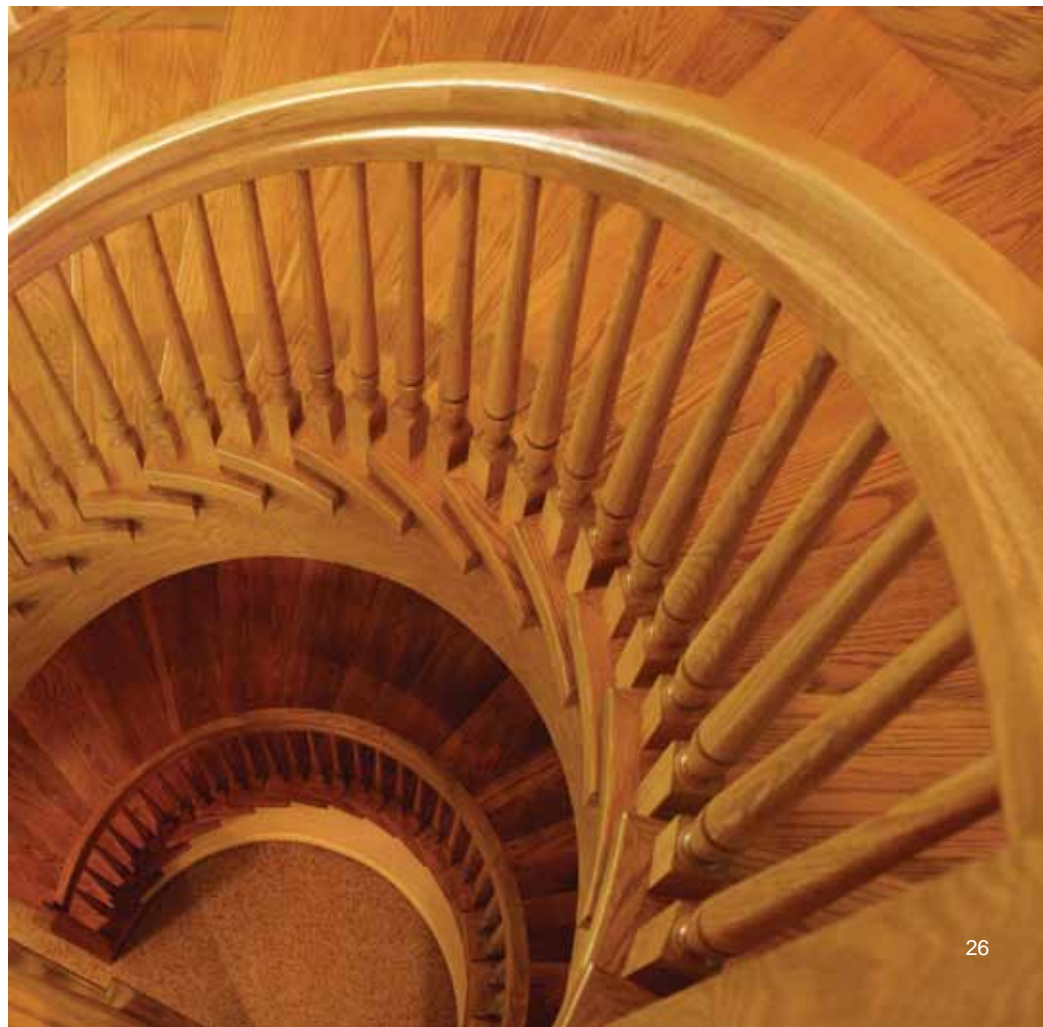

Harmony Collection



Post to Post

Non-Plowed Handrails and Pin Top Balusters

Plowed Handrails and Square Top Balusters



Shoerail & Fillet

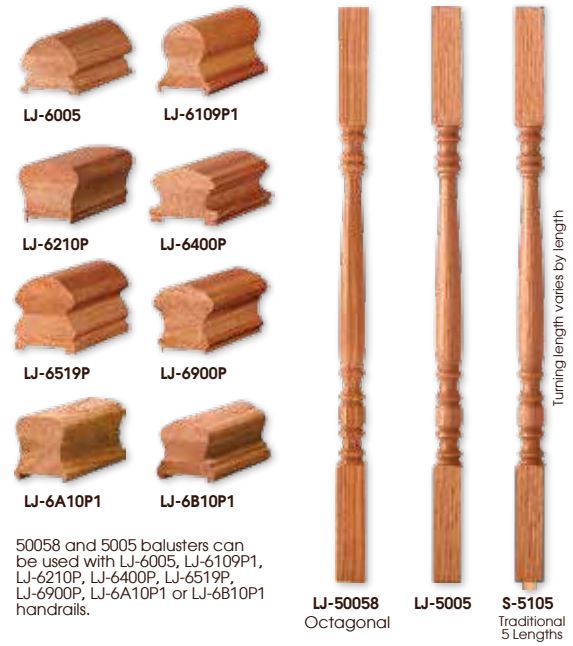

53008 and 5300 balusters can be used with LJ-6109, LJ-6210, LJ-6400, LJ-6519, LJ-6701, LJ-6900, LJ-6A10 or LJ-6B10 handrails.

50058 and 5005 balusters can be used with LJ-6005, LJ-6109P1, LJ-6210P, LJ-6400P, LJ-6519P, LJ-6900P, LJ-6A10P1 or LJ-6B10P1 handrails.

"LJ-" series balusters are pre-drilled with a 9/32" (7 mm) diameter hole at least 3" (76 mm) deep in which a pin ("Pin E-Z") is loosely inserted. The balusters can then be installed in the traditional manner, or by using the Dowel-Fast™ screws as shown on page 85 (sold separately). "S-" series balusters have a turned bottom pin.

Product Dimensions					
Handrails:	Height	Profile Width	Bottom Width	Plow Width	
LJ-6005	2 3/4" (69 mm)	2 1/2" (64 mm)	2 1/2" (64 mm)	1 3/4" (44 mm)	
LJ-6109	2 1/4" (73 mm)	1 1/2" (48 mm)	2 3/8" (60 mm)	N/A	
LJ-6109P1	2 1/4" (73 mm)	1 1/2" (48 mm)	2 3/8" (60 mm)	1 3/4" (44 mm)	
LJ-6210	2 3/8" (60 mm)	2 3/8" (67 mm)	2" (51 mm)	N/A	
LJ-6210P	2 3/8" (60 mm)	2 3/8" (67 mm)	2" (51 mm)	1 3/4" (44 mm)	
LJ-6400	2 1/4" (67 mm)	2 3/4" (70 mm)	3" (76 mm)	N/A	
LJ-6400P	2 1/4" (67 mm)	2 3/4" (70 mm)	3" (76 mm)	1 3/4" (44 mm)	
LJ-6519	3" (76 mm)	2 3/8" (67 mm)	2 3/8" (67 mm)	N/A	
LJ-6519P	3" (76 mm)	2 3/8" (67 mm)	2 3/8" (67 mm)	1 3/4" (44 mm)	
LJ-6701	2 1/2" (64 mm)	2 3/4" (70 mm)	1 3/4" (41 mm)	N/A	
LJ-6900	2 3/4" (70 mm)	2 3/8" (67 mm)	1 1/2" (49 mm)	N/A	
LJ-6900P	2 3/4" (70 mm)	2 3/8" (67 mm)	1 1/2" (49 mm)	1 3/4" (44 mm)	
LJ-6A10	2 3/8" (60 mm)	2" (51 mm)	2 1/4" (54 mm)	N/A	
LJ-6A10P1	2 3/8" (60 mm)	2" (51 mm)	2 1/4" (54 mm)	1 3/4" (44 mm)	
LJ-6B10	2 3/8" (60 mm)	2" (51 mm)	2 3/8" (60 mm)	N/A	
LJ-6B10P1	2 3/8" (60 mm)	2" (51 mm)	2 3/8" (60 mm)	1 3/4" (44 mm)	
Shoerail and Fillet:	Height	Width	Plow Width		
LJ-6006	1" (25 mm)	3 1/2" (79 mm)	1 3/4" (44 mm)		
LJ-6007	3/4" (19 mm)	1 3/4" (44 mm)			
Balusters:	Top Block	Turning Length	Bottom Block	Square Size	Overall Length
LJ-5005ND-31‡	5 1/8" (149 mm)	16 3/8" (422 mm)	8 1/2" (216 mm)	1 3/4" (44 mm)	31" (787 mm)
LJ-5005(8)-34	7" (178 mm)	20" (508 mm)	7" (178 mm)	1 3/4" (44 mm)	34" (864 mm)
LJ-5005(8)-38	7" (178 mm)	20" (508 mm)	11" (279 mm)	1 3/4" (44 mm)	38" (965 mm)
LJ-5005(8)-42	7" (178 mm)	20" (508 mm)	15" (381 mm)	1 3/4" (44 mm)	42" (1067 mm)
S-5105-31	5 1/8" (149 mm)	16 3/8" (422 mm)	7 3/4" (197 mm)	1 3/4" (44 mm)	31" (787 mm)
S-5105-34	5 1/8" (149 mm)	19 3/8" (498 mm)	7 3/4" (197 mm)	1 3/4" (44 mm)	34" (864 mm)
S-5105-36	5 1/8" (149 mm)	21 1/8" (549 mm)	7 3/4" (197 mm)	1 3/4" (44 mm)	36" (914 mm)
S-5105-39	5 1/8" (149 mm)	24 3/8" (625 mm)	7 3/4" (197 mm)	1 3/4" (44 mm)	39" (991 mm)
S-5105-42	8 1/4" (206 mm)	25 3/8" (645 mm)	7 3/4" (197 mm)	1 3/4" (44 mm)	42" (1067 mm)
LJ-5300(8)-34	N/A	27" (686 mm)	7" (178 mm)	1 3/4" (44 mm)	34" (864 mm)
LJ-5300(8)-38	N/A	27" (686 mm)	11" (279 mm)	1 3/4" (44 mm)	38" (965 mm)
LJ-5300(8)-42	N/A	27" (686 mm)	15" (381 mm)	1 3/4" (44 mm)	42" (1067 mm)
S-5300-31	N/A	22 1/2" (572 mm)	7 3/4" (197 mm)	1 3/4" (44 mm)	31" (787 mm)
S-5300-34	N/A	25 1/2" (648 mm)	7 3/4" (197 mm)	1 3/4" (44 mm)	34" (864 mm)
S-5300-36	N/A	27 1/2" (698 mm)	7 3/4" (197 mm)	1 3/4" (44 mm)	36" (914 mm)
S-5300-39	N/A	30 1/2" (775 mm)	7 3/4" (197 mm)	1 3/4" (44 mm)	39" (991 mm)
S-5300-42	N/A	33 1/2" (851 mm)	7 3/4" (197 mm)	1 3/4" (44 mm)	42" (1067 mm)

Product Dimensions						
Newel Posts:	Finial	Top Block	Turning Length	Bottom Block	Square Size	Overall Length
Utility Newels						
LJ-4500(8)	3 1/2" (89 mm)	5" (127 mm)	23" (584 mm)	16 1/4" (413 mm)	3 1/2" (89 mm)	48" (1219 mm)
LJ-4504(8)	3 1/2" (89 mm)	5" (127 mm)	23" (584 mm)	26 1/4" (668 mm)	3 1/2" (89 mm)	58" (1473 mm)
LJ-4004	4 1/2" (114 mm)	N/A	N/A	N/A	3 1/2" (89 mm)	48" (1219 mm)
LJ-4004COL	4 1/4" (112 mm)	N/A	N/A	N/A	3 1/2" (89 mm)	48" (1219 mm)
LJ-4004RT	3 1/2" (89 mm)	N/A	N/A	N/A	3 1/2" (89 mm)	48" (1219 mm)
Second Floor Landing Newel						
LJ-4503(8)	3 1/2" (89 mm)	11" (279 mm)	19 1/2" (495 mm)	23 3/4" (603 mm)	3 1/2" (89 mm)	58" (1473 mm)
LJ-4005	4 1/2" (114 mm)	N/A	N/A	N/A	3 1/2" (89 mm)	58" (1473 mm)
LJ-4005COL	4 1/4" (112 mm)	N/A	N/A	N/A	3 1/2" (89 mm)	58" (1473 mm)
LJ-4005RT	3 1/2" (89 mm)	N/A	N/A	N/A	3 1/2" (89 mm)	58" (1473 mm)
Intermediate Landing Newels						
LJ-4505(8)	3 1/2" (89 mm)	14 1/2" (368 mm)	16" (406 mm)	38 3/4" (984 mm)	3 1/2" (89 mm)	73" (1854 mm)
LJ-4558(8)	3 1/2" (89 mm)	5" (127 mm)	23" (584 mm)	46 1/4" (1175 mm)	3 1/2" (89 mm)	78" (1981 mm)
LJ-4006	4 1/2" (114 mm)	N/A	N/A	N/A	3 1/2" (89 mm)	73" (1854 mm)
LJ-4006COL	4 1/4" (112 mm)	N/A	N/A	N/A	3 1/2" (89 mm)	73" (1854 mm)
LJ-4006RT	3 1/2" (89 mm)	N/A	N/A	N/A	3 1/2" (89 mm)	73" (1854 mm)

Picture Right: LJ-6519 Handrail, LJ-5300 Balusters with LIH-HOL50144 and LIH-HOL1TW44 Iron Balusters.

Picture Far Right: LJ-6519P Handrail, LJ-6006 Shoerail, LJ-6007 Fillet, LJ-4500 Newels and LJ-5005 Balusters.



‡ Length is from the top of the bottom block to the top of the baluster. This baluster is for kneewall stairways only. It is NOT predrilled and does NOT include the Pin EZ.

Newel Posts

Newel Drop



LJ-4299A



LJ-45008
LJ-45048
LJ-45588†



LJ-45038



LJ-45058



LJ-4500
LJ-4504
LJ-4558†



LJ-4503



LJ-4505



LJ-3513PT



LJ-4004
LJ-4005
LJ-4006



LJ-4004COL
LJ-4005COL
LJ-4006COL



LJ-4004RT
LJ-4005RT
LJ-4006RT

Box Newels

Octagonal Option

† Requires a landing fitting assembly (gooseneck pp 77-78)

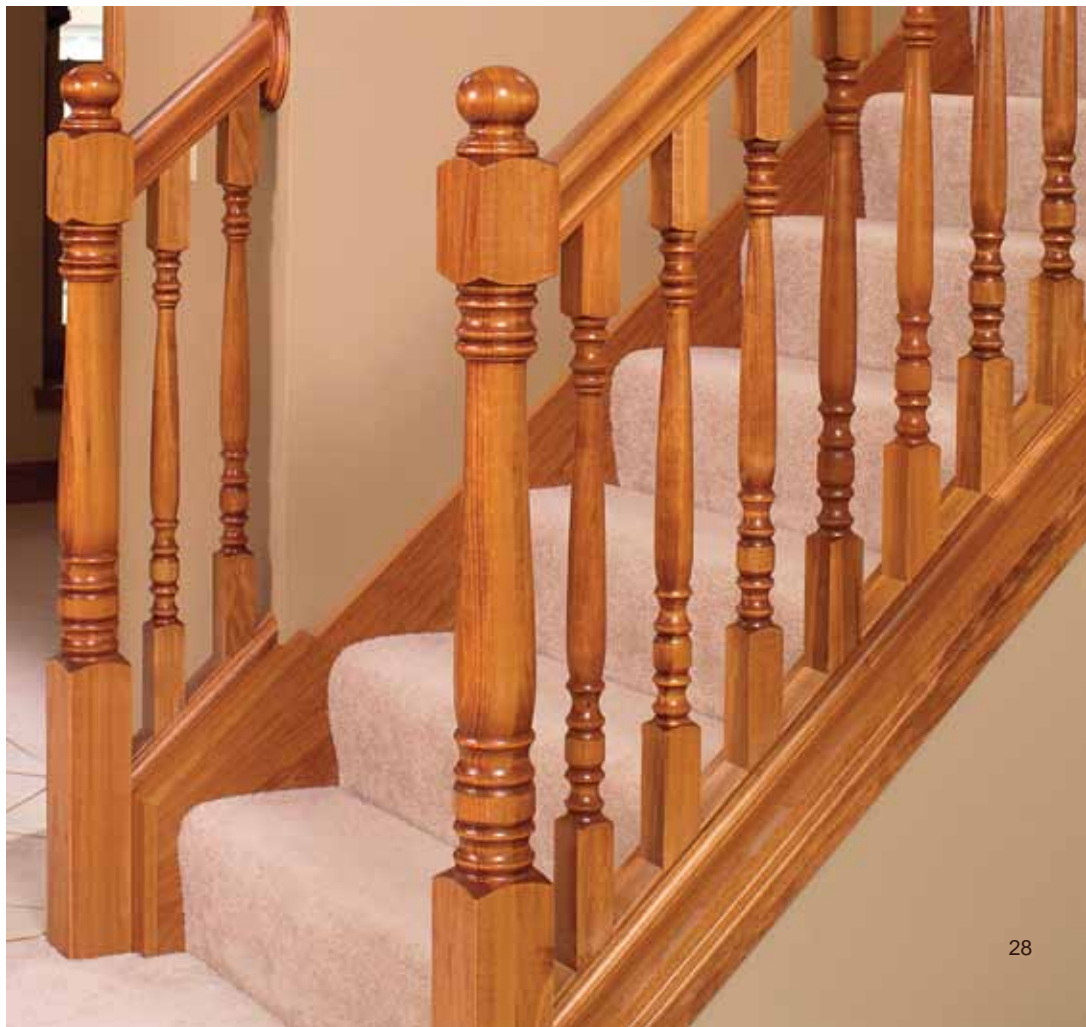

Classic Collection

Non-Plowed Handrails and Pin Top Balusters



LJ-5200 balusters can be used with LJ-6002, LJ-6010, LJ-6109, LJ-6601, LJ-6A10 or LJ-6B10 handrails.

Plowed Handrails and Square Top Balusters



LJ-5004 balusters can be used with LJ-6000, LJ-6010P, LJ-6109P0, LJ-6601P, LJ-6A10P0 or LJ-6B10P0 handrails.

Shoerail & Fillet



Newel Posts



Consider box newels for your stairway from our Hierloom Collection on pages 36-41

Balusters on this page are pre-drilled with a 9/32" (7 mm) diameter hole at least 3" (76 mm) deep in which a pin ("Pin E-Z") is loosely inserted. Every baluster can then be installed in the traditional manner, or by using the Dowel-Fast™ screws as shown on page 85 (sold separately).

† Requires a landing fitting assembly (gooseneck pp 77-78)

Product Dimensions

Handrails:	Height	Profile Width	Bottom Width	Plow Width		
LJ-6000	1 3/4" (41 mm)	2 3/4" (70 mm)	2 3/4" (70 mm)	1 1/4" (32 mm)		
LJ-6002	1 3/4" (41 mm)	2 3/4" (70 mm)	2 3/4" (70 mm)	N/A		
LJ-6010	2 3/8" (60 mm)	2 1/2" (57 mm)	1 1/2" (38 mm)	N/A		
LJ-6010P	2 3/8" (60 mm)	2 1/4" (57 mm)	1 1/2" (38 mm)	1 1/4" (32 mm)		
LJ-6109	2 7/8" (73 mm)	1 1/4" (48 mm)	2 3/8" (60 mm)	N/A		
LJ-6109P0	2 7/8" (73 mm)	1 1/4" (48 mm)	2 3/8" (60 mm)	1 1/4" (32 mm)		
LJ-6601	2 1/4" (57 mm)	2 1/4" (57 mm)	1 1/2" (38 mm)	N/A		
LJ-6601P	2 1/4" (57 mm)	2 1/4" (57 mm)	1 1/2" (38 mm)	1 1/4" (32 mm)		
LJ-6A10	2 3/8" (60 mm)	2" (51 mm)	2 1/8" (54 mm)	N/A		
LJ-6A10P0	2 3/8" (60 mm)	2" (51 mm)	2 1/8" (54 mm)	1 1/4" (32 mm)		
LJ-6B10	2 3/16" (59 mm)	2" (51 mm)	2 3/8" (60 mm)	N/A		
LJ-6B10P0	2 3/16" (59 mm)	2" (51 mm)	2 3/8" (60 mm)	1 1/4" (32 mm)		
Shoerail and Fillet:	Height	Width	Plow Width			
LJ-6045	3/4" (19 mm)	2 1/2" (64 mm)	1 1/4" (32 mm)			
LJ-6050	3/8" (10 mm)	1 1/4" (32 mm)	N/A			
Balusters:	Top Block	Turning Length	Bottom Block	Square Size	Overall Length	
LJ-5004ND-31†	5 1/4" (149 mm)	16 3/4" (422 mm)	8 1/2" (216 mm)	1 1/4" (32 mm)	31" (787 mm)	
LJ-5004-34	7" (178 mm)	20" (508 mm)	7" (178 mm)	1 1/4" (32 mm)	34" (864 mm)	
LJ-5004-38	7" (178 mm)	20" (508 mm)	11" (279 mm)	1 1/4" (32 mm)	38" (965 mm)	
LJ-5004-42	7" (178 mm)	20" (508 mm)	15" (381 mm)	1 1/4" (32 mm)	42" (1067 mm)	
LJ-5200-34	N/A	27 7/8" (686 mm)	7" (178 mm)	1 1/4" (32 mm)	34" (864 mm)	
LJ-5200-38	N/A	27 7/8" (686 mm)	11" (279 mm)	1 1/4" (32 mm)	38" (965 mm)	
LJ-5200-42	N/A	27 7/8" (686 mm)	15" (381 mm)	1 1/4" (32 mm)	42" (1067 mm)	
Newel Posts:	Finial	Top Block	Turning Length	Bottom Block	Square Size	Overall Length
Utility Newels						
LJ-4600	3 7/16" (87 mm)	5" (127 mm)	23" (584 mm)	16 1/4" (413 mm)	3" (76 mm)	48" (1219 mm)
LJ-4604	3 7/16" (87 mm)	5" (127 mm)	23" (584 mm)	26 1/4" (668 mm)	3" (76 mm)	58" (1473 mm)
Second Floor Landing Newel						
LJ-4603	3 7/16" (87 mm)	11" (279 mm)	19 1/2" (495 mm)	23 3/4" (603 mm)	3" (76 mm)	58" (1473 mm)
Intermediate Landing Newels						
LJ-4605	3 7/16" (87 mm)	14 1/2" (368 mm)	16" (406 mm)	38 3/4" (984 mm)	3" (76 mm)	73" (1854 mm)
LJ-4658	3 7/16" (87 mm)	5" (127 mm)	23" (584 mm)	46 1/4" (1175 mm)	3" (76 mm)	78" (1981 mm)
Rake Newel						
LJ-3513PT	N/A	N/A	27 7/8" (706 mm)	20 7/8" (533 mm)	3" (76 mm)	48" (1219 mm)



Pictured: LJ-6010P Handrail, LJ-4600 Utility Newels and LJ-5004 Balusters.

Non-Plowed Handrails and Pin Top Balusters



LJ-5V15 and LJ-5V35 balusters can be used with LJ-6V10, LJ-6210, LJ-6519 or LJ-6900 handrails.

Plowed Handrails and Square Top Balusters



LJ-5V05 and LJ-5V25 balusters can be used with LJ-6V10P, LJ-6210P, LJ-6519P or LJ-6900P handrails.

Shoerail & Fillet



Newel Posts



Box Newels
LJ-4V40-5.0
LJ-4V42-5.0
LJ-4V58-5.0†

Consider box newels for your stairway from our Hierloom Collection on pages 36-41

Post to Post

Balusters on this page are pre-drilled with a 9/32" (7 mm) diameter hole at least 3" (76 mm) deep in which a pin ("Pin E-Z") is loosely inserted. Every baluster can then be installed in the traditional manner, or by using the Dowel-Fast™ screws as shown on page 85 (sold separately).

† Requires a landing fitting assembly (gooseneck pp 77-78)

Product Dimensions						
Handrails:	Height		Profile Width	Bottom Width	Plow Width	
LJ-6V10	2½" (64 mm)		2½" (67 mm)	2½" (64 mm)	N/A	
LJ-6V10P	2½" (64 mm)		2½" (67 mm)	2½" (64 mm)	1¾" (44 mm)	
LJ-6210	2½" (60 mm)		2½" (67 mm)	2" (51 mm)	N/A	
LJ-6210P	2½" (60 mm)		2½" (67 mm)	2" (51 mm)	1¾" (44 mm)	
LJ-6519	3" (76 mm)		2½" (67 mm)	2½" (67 mm)	N/A	
LJ-6519P	3" (76 mm)		2½" (67 mm)	2½" (67 mm)	1¾" (44 mm)	
LJ-6900	2¾" (70 mm)		2½" (67 mm)	1½" (49 mm)	N/A	
LJ-6900P	2¾" (70 mm)		2½" (67 mm)	1½" (49 mm)	1¾" (44 mm)	
Shoerail and Fillet:	Height		Width		Plow Width	
LJ-6006	1" (25 mm)		3¼" (79 mm)		1¾" (44 mm)	
LJ-6007	¾" (8 mm)		1¾" (44 mm)		N/A	
Balusters:	Top Block	Turning Length	Bottom Block	Square Size	Overall Length	
LJ-5V05-34	6¼" (166 mm)	20¼" (516 mm)	7¼" (181 mm)	1¾" (44 mm)	34" (864 mm)	
LJ-5V05-38	6¼" (166 mm)	20¼" (516 mm)	11½" (283 mm)	1¾" (44 mm)	38" (965 mm)	
LJ-5V05-42	6¼" (166 mm)	20¼" (516 mm)	15½" (384 mm)	1¾" (44 mm)	42" (1067 mm)	
LJ-5V15-34	N/A	26¾" (682 mm)	7¼" (181 mm)	1¾" (44 mm)	34" (864 mm)	
LJ-5V15-38	N/A	26¾" (682 mm)	11½" (283 mm)	1¾" (44 mm)	38" (965 mm)	
LJ-5V15-42	N/A	26¾" (682 mm)	15½" (384 mm)	1¾" (44 mm)	42" (1067 mm)	
LJ-5V25-34	6¼" (166 mm)	20¼" (516 mm)	7¼" (181 mm)	1¾" (44 mm)	34" (864 mm)	
LJ-5V25-38	6¼" (166 mm)	20¼" (516 mm)	11½" (283 mm)	1¾" (44 mm)	38" (965 mm)	
LJ-5V25-42	6¼" (166 mm)	20¼" (516 mm)	15½" (384 mm)	1¾" (44 mm)	42" (1067 mm)	
LJ-5V35-34	N/A	26¾" (682 mm)	7¼" (181 mm)	1¾" (44 mm)	34" (864 mm)	
LJ-5V35-38	N/A	26¾" (682 mm)	11½" (283 mm)	1¾" (44 mm)	38" (965 mm)	
LJ-5V35-42	N/A	26¾" (682 mm)	15½" (384 mm)	1¾" (44 mm)	42" (1067 mm)	
Newel Posts:	Finial	Top Block	Turning Length	Bottom Block	Square Size	Overall Length
Utility Newels						
LJ-4V40-5.0	5¾" (137 mm)	5¼" (133 mm)	20½" (521 mm)	16¾" (416 mm)	5" (127 mm)	48" (1219 mm)
LJ-4V42-5.0	5¾" (137 mm)	5¼" (133 mm)	20½" (521 mm)	26¾" (670 mm)	5" (127 mm)	58" (1473 mm)
Landing Newel						
LJ-4V58-5.0	5¾" (137 mm)	5¼" (133 mm)	20½" (521 mm)	44¾" (1127 mm)	5" (127 mm)	78" (1981 mm)

* Length is from the top of the bottom block to the top of the baluster



Pictured: LJ-6V10P Handrail, LJ-4V40-5.0 Newel and LJ-5V05 Balusters.

Non-Plowed Handrails and Pin Top Balusters

Plowed Handrails and Square Top Balusters

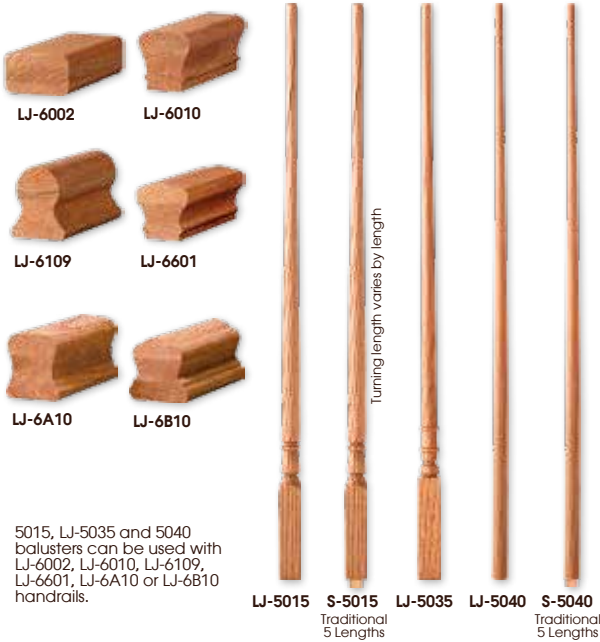

5015, LJ-5035 and 5040 balusters can be used with LJ-6002, LJ-6010, LJ-6109, LJ-6601, LJ-6A10 or LJ-6B10 handrails.

Shoerail & Fillet

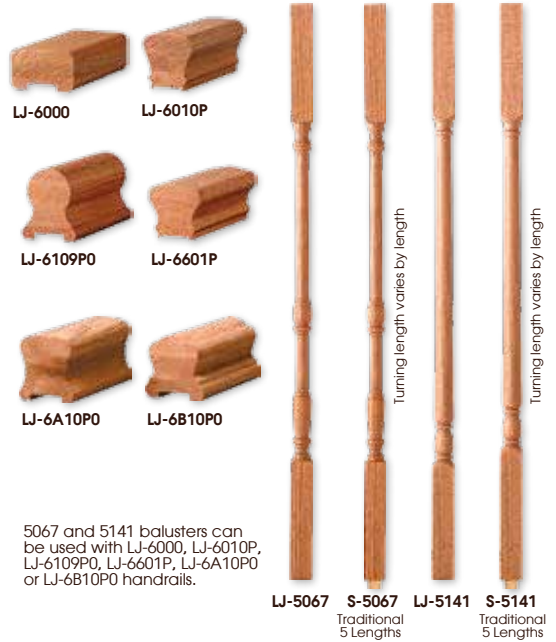

5067 and 5141 balusters can be used with LJ-6000, LJ-6010P, LJ-6109P0, LJ-6601P, LJ-6A10P0 or LJ-6B10P0 handrails.

"LJ-" series balusters are pre-drilled with a 9/32"(7 mm) diameter hole at least 3"(76 mm) deep in which a pin ("Pin E-Z") is loosely inserted. The balusters can then be installed in the traditional manner, or by using the Dowel-Fast™ screws as shown on page 85 (sold separately). "S-" series balusters have a turned bottom pin.

Product Dimensions

Handrails:	Height	Profile Width	Bottom Width	Plow Width
LJ-6000	1 3/8" (41 mm)	2 3/4" (70 mm)	2 3/4" (70 mm)	1 1/4" (32 mm)
LJ-6002	1 3/8" (41 mm)	2 3/4" (70 mm)	2 3/4" (70 mm)	N/A
LJ-6010	2 3/4" (69 mm)	2 1/4" (57 mm)	1 1/2" (38 mm)	N/A
LJ-6010P	2 3/4" (69 mm)	2 1/4" (57 mm)	1 1/2" (38 mm)	1 1/4" (32 mm)
LJ-6109	2 1/8" (73 mm)	1 1/8" (48 mm)	2 3/4" (69 mm)	N/A
LJ-6109P0	2 1/8" (73 mm)	1 1/8" (48 mm)	2 3/4" (69 mm)	1 1/4" (32 mm)
LJ-6601	2 1/4" (57 mm)	2 1/4" (57 mm)	1 1/2" (38 mm)	N/A
LJ-6601P	2 1/4" (57 mm)	2 1/4" (57 mm)	1 1/2" (38 mm)	1 1/4" (32 mm)
LJ-6A10	2 3/4" (69 mm)	2" (51 mm)	2 1/4" (57 mm)	N/A
LJ-6A10P0	2 3/4" (69 mm)	2" (51 mm)	2 1/4" (57 mm)	1 1/4" (32 mm)
LJ-6B10	2 3/4" (69 mm)	2" (51 mm)	2 3/4" (69 mm)	N/A
LJ-6B10P0	2 3/4" (69 mm)	2" (51 mm)	2 3/4" (69 mm)	1 1/4" (32 mm)

Shoerail and Fillet:	Height	Width	Plow Width
LJ-6045	3/4" (19 mm)	2 1/2" (64 mm)	1 1/4" (32 mm)
LJ-6050	3/8" (10 mm)	1 1/4" (32 mm)	N/A

Balusters:	Top Block	Turning Length	Bottom Block	Square Size	Overall Length
LJ-5015ND-31‡	N/A	22 3/8" (575 mm)	8 3/8" (213 mm)	1 1/4" (32 mm)	31" (787 mm)
LJ-5015-34	N/A	28" (711 mm)	6" (152 mm)	1 1/4" (32 mm)	34" (864 mm)
LJ-5015-38	N/A	28" (711 mm)	10" (254 mm)	1 1/4" (32 mm)	38" (965 mm)
LJ-5015-42	N/A	28" (711 mm)	14" (356 mm)	1 1/4" (32 mm)	42" (1067 mm)
S-5015-31	N/A	22 3/8" (575 mm)	7 3/8" (193 mm)	1 1/4" (32 mm)	31" (787 mm)
S-5015-34	N/A	25 3/8" (651 mm)	7 3/8" (193 mm)	1 1/4" (32 mm)	34" (864 mm)
S-5015-36	N/A	27 3/8" (702 mm)	7 3/8" (193 mm)	1 1/4" (32 mm)	36" (914 mm)
S-5015-39	N/A	30 3/8" (778 mm)	7 3/8" (193 mm)	1 1/4" (32 mm)	39" (990 mm)
S-5015-42	N/A	33 3/8" (854 mm)	7 3/8" (193 mm)	1 1/4" (32 mm)	42" (1067 mm)
LJ-5035-34	N/A	28" (711 mm)	6" (152 mm)	1 1/4" (32 mm)	34" (864 mm)
LJ-5035-38	N/A	28" (711 mm)	10" (254 mm)	1 1/4" (32 mm)	38" (965 mm)
LJ-5035-42	N/A	28" (711 mm)	14" (356 mm)	1 1/4" (32 mm)	42" (1067 mm)
LJ-5040-34	N/A	34" (864 mm)	N/A	1 1/2" diam. (29 mm)	34" (864 mm)
LJ-5040-38	N/A	38" (965 mm)	N/A	1 1/2" diam. (29 mm)	38" (965 mm)
LJ-5040-42	N/A	42" (1067 mm)	N/A	1 1/2" diam. (29 mm)	42" (1067 mm)
S-5040-31	N/A	30 3/4" (768 mm)	N/A	1 1/2" diam. (29 mm)	31" (787 mm)
S-5040-34	N/A	33 3/4" (845 mm)	N/A	1 1/2" diam. (29 mm)	34" (864 mm)
S-5040-36	N/A	35 3/4" (895 mm)	N/A	1 1/2" diam. (29 mm)	36" (914 mm)
S-5040-39	N/A	38 3/4" (972 mm)	N/A	1 1/2" diam. (29 mm)	39" (990 mm)
S-5040-42	N/A	41 3/4" (1048 mm)	N/A	1 1/2" diam. (29 mm)	42" (1067 mm)
LJ-5067-34	7" (178 mm)	20" (508 mm)	7" (178 mm)	1 1/4" (32 mm)	34" (864 mm)
LJ-5067-38	7" (178 mm)	20" (508 mm)	11" (279 mm)	1 1/4" (32 mm)	38" (965 mm)
LJ-5067-42	7" (178 mm)	20" (508 mm)	15" (381 mm)	1 1/4" (32 mm)	42" (1067 mm)
S-5067-31	5 1/4" (133 mm)	19 3/8" (486 mm)	5 7/8" (149 mm)	1 1/4" (32 mm)	31" (787 mm)
S-5067-34	5 5/8" (149 mm)	21 1/2" (546 mm)	5 7/8" (149 mm)	1 1/4" (32 mm)	34" (864 mm)
S-5067-36	5 5/8" (136 mm)	24" (610 mm)	5 7/8" (149 mm)	1 1/4" (32 mm)	36" (914 mm)
S-5067-39	5 1/4" (133 mm)	27 1/8" (689 mm)	5 7/8" (149 mm)	1 1/4" (32 mm)	39" (990 mm)
S-5067-42	7 3/8" (194 mm)	27 3/4" (705 mm)	5 7/8" (149 mm)	1 1/4" (32 mm)	42" (1067 mm)

‡ This baluster is for kneewall stairways only. It is NOT predrilled and does NOT include the Pin EZ.

Product Dimensions

Balusters:	Top Block	Turning Length	Bottom Block	Square Size	Overall Length
LJ-5141ND-31‡	5 1/4" (133 mm)	16 3/4" (425 mm)	9" (229 mm)	1 1/4" (32 mm)	31" (787 mm)
LJ-5141-34	7" (178 mm)	20" (508 mm)	7" (178 mm)	1 1/4" (32 mm)	34" (864 mm)
LJ-5141-38	7" (178 mm)	20" (508 mm)	11" (279 mm)	1 1/4" (32 mm)	38" (965 mm)
LJ-5141-42	7" (178 mm)	20" (508 mm)	15" (381 mm)	1 1/4" (32 mm)	42" (1067 mm)
S-5141-31	5 1/4" (133 mm)	16 3/4" (425 mm)	8 3/4" (210 mm)	1 1/4" (32 mm)	31" (787 mm)
S-5141-34	6 3/4" (159 mm)	18 3/4" (476 mm)	8 3/4" (210 mm)	1 1/4" (32 mm)	34" (864 mm)
S-5141-36	6 3/4" (159 mm)	20 3/4" (527 mm)	8 3/4" (210 mm)	1 1/4" (32 mm)	36" (914 mm)
S-5141-39	6 3/4" (159 mm)	23 3/4" (603 mm)	8 3/4" (210 mm)	1 1/4" (32 mm)	39" (990 mm)
S-5141-42	6 3/4" (159 mm)	26 3/4" (679 mm)	8 3/4" (210 mm)	1 1/4" (32 mm)	42" (1067 mm)

‡ This Baluster is for kneewall stairways only. It is NOT predrilled and does NOT include the Pin EZ.

Newel Posts:	Finial	Top Block	Turning Length	Bottom Block	Square Size	Overall Length
Utility Newels						
LJ-4040	2 5/8" (67 mm)	5" (127 mm)	23" (584 mm)	17" (431 mm)	3" (76 mm)	48" (1219 mm)
LJ-4042	2 5/8" (67 mm)	5" (127 mm)	23" (584 mm)	27" (686 mm)	3" (76 mm)	58" (1473 mm)
LJ-4150	3 3/4" (95 mm)	5" (127 mm)	23" (584 mm)	16" (406 mm)	3" (76 mm)	48" (1219 mm)
LJ-4152	3 3/4" (95 mm)	5" (127 mm)	23" (584 mm)	26" (660 mm)	3" (76 mm)	58" (1473 mm)
LJ-4180	2 5/8" (67 mm)	5" (127 mm)	23" (584 mm)	17" (431 mm)	3 1/2" (83 mm)	48" (1219 mm)
LJ-4182	2 5/8" (67 mm)	5" (127 mm)	23" (584 mm)	27" (686 mm)	3 1/2" (83 mm)	58" (1473 mm)
Second Floor Landing Newel						
LJ-4045	2 5/8" (67 mm)	11" (279 mm)	19 1/2" (495 mm)	24 1/2" (622 mm)	3" (76 mm)	58" (1473 mm)
LJ-4155	3 3/4" (95 mm)	11" (279 mm)	19 1/2" (495 mm)	23 1/2" (597 mm)	3" (76 mm)	58" (1473 mm)
LJ-4185	2 5/8" (67 mm)	11" (279 mm)	19 1/2" (495 mm)	24 1/2" (622 mm)	3 1/2" (83 mm)	58" (1473 mm)
Intermediate Landing Newels						
LJ-4046	2 5/8" (67 mm)	14 1/2" (368 mm)	16" (406 mm)	39 1/2" (1003 mm)	3" (76 mm)	73" (1854 mm)
LJ-4053	2 5/8" (67 mm)	5" (127 mm)	23" (584 mm)	31" (787 mm)	3" (76 mm)	62" (1574 mm)
LJ-4055	2 5/8" (67 mm)	5" (127 mm)	23" (584 mm)	42" (1067 mm)	3" (76 mm)	73" (1854 mm)
LJ-4058	2 5/8" (67 mm)	5" (127 mm)	23" (584 mm)	47" (1193 mm)	3" (76 mm)	78" (1981 mm)
LJ-4156	3 3/4" (95 mm)	14 1/2" (368 mm)	16" (406 mm)	38 1/2" (978 mm)	3" (76 mm)	73" (1854 mm)
LJ-4168	3 3/4" (95 mm)	5" (127 mm)	23" (584 mm)	46" (1168 mm)	3" (76 mm)	78" (1981 mm)
LJ-4186	2 5/8" (67 mm)	14 1/2" (368 mm)	16" (406 mm)	39 1/2" (1003 mm)	3 1/2" (83 mm)	73" (1854 mm)
LJ-4198	2 5/8" (67 mm)	5" (127 mm)	23" (584 mm)	47" (1193 mm)	3 1/2" (83 mm)	78" (1981 mm)
Rake Newel						
LJ-4013PT	N/A	N/A	27" (686 mm)	16" (406 mm)	3" (76 mm)	43" (1029 mm)

Pictured Right: LJ-6B10P0 Handrail, LJ-6045 Shoerail, LJ-4040 Newels and LJ-5141 Balusters.

Pictured Far Right: LJ-6601 Handrail and LJ-5040 Balusters.

Newel Posts

Newel Drop



LJ-4099A



LJ-4180
LJ-4182
LJ-4198†

LJ-4185

LJ-4186

LJ-4150
LJ-4152
LJ-4168†

LJ-4155

LJ-4156

LJ-4013PT

Available in Ball Top Specify "BT" suffix (LJ-4040BT)

LJ-4040
LJ-4042
LJ-4053†
LJ-4055†
LJ-4058†

LJ-4045

LJ-4046

Box Newels

† Requires a landing fitting assembly (gooseneck pp 77-78)



Handrails and Square Balusters

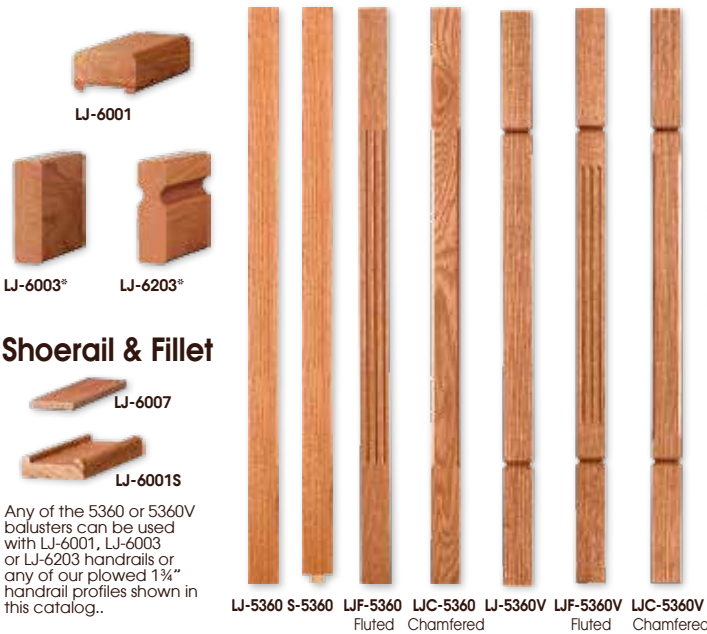

Non-Plowed Handrails and Round Balusters

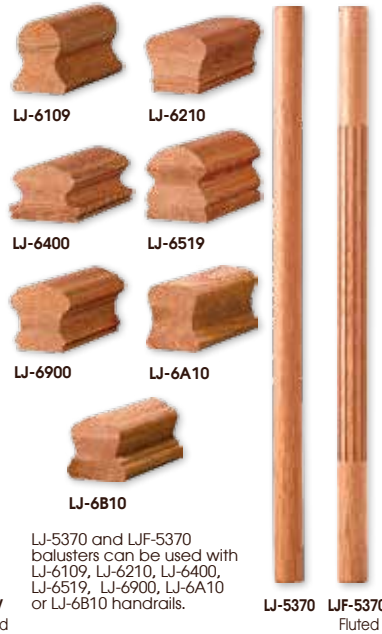

Newel Posts



*This rail profile is used when the balusters will be side mounted to the handrail.

NOTE: the balusters on this page are not pre-drilled, nor do they come with a ("Pin E-Z").

Product Dimensions

Handrails:	Height	Profile Width	Bottom Width	Plow Width
LJ-6001	1 1/4" (41 mm)	2 3/4" (70 mm)	2 3/4" (70 mm)	1 3/4" (44 mm)
LJ-6003	5 1/4" (140 mm)	1 1/2" (41 mm)	1 1/2" (41 mm)	N/A
LJ-6109	2 1/4" (73 mm)	1 1/4" (48 mm)	2 3/4" (69 mm)	N/A
LJ-6203	5 1/2" (140 mm)	1 1/2" (41 mm)	1 1/2" (41 mm)	N/A
LJ-6210	2 5/8" (69 mm)	2 5/8" (69 mm)	2" (51 mm)	N/A
LJ-6400	2 1/4" (67 mm)	2 3/4" (70 mm)	3" (76 mm)	N/A
LJ-6519	3" (76 mm)	2 5/8" (69 mm)	2 5/8" (69 mm)	N/A
LJ-6900	2 3/4" (70 mm)	2 3/4" (67 mm)	1 1/4" (49 mm)	N/A
LJ-6A10	2 5/8" (69 mm)	2" (51 mm)	2 1/8" (54 mm)	N/A
LJ-6B10	2 5/8" (69 mm)	2" (51 mm)	2 5/8" (69 mm)	N/A

Shoerail and Fillet:	Height	Width	Plow Width
LJ-6001S	3/4" (19 mm)	2 1/2" (64 mm)	1 3/4" (44 mm)
LJ-6007	5/16" (8 mm)	1 3/4" (44 mm)	N/A

Balusters:	Top Block	Detail Length	Bottom Block	Square Size	Overall Length
LJ-5360	1 3/4" (44 mm)	Square x 34" (864 mm)	38" (965 mm), or 42" (1067 mm)		
S-5360	1 3/4" (44 mm)	Square x 31" (787 mm)	34" (864 mm), 36" (914 mm), 39" (990 mm), or 42" (1067 mm)		
LJF-5360-34	7" (178 mm)	20" (508 mm)	7" (178 mm)	1 3/4" (44 mm) Square	34" (864 mm)
LJF-5360-38	7" (178 mm)	20" (508 mm)	11" (279 mm)	1 3/4" (44 mm) Square	38" (965 mm)
LJF-5360-42	7" (178 mm)	20" (508 mm)	15" (381 mm)	1 3/4" (44 mm) Square	42" (1067 mm)
LJC-5360-34	5 1/2" (149 mm)	18 1/2" (460 mm)	10" (254 mm)	1 3/4" (44 mm) Square	34" (864 mm)
LJC-5360-38	5 1/2" (149 mm)	18 1/2" (460 mm)	14" (356 mm)	1 3/4" (44 mm) Square	38" (965 mm)
LJC-5360-42	5 1/2" (149 mm)	18 1/2" (460 mm)	18" (457 mm)	1 3/4" (44 mm) Square	42" (1067 mm)
All 5360V-34	7 1/4" (184 mm)	19 1/2" (495 mm)	7 1/4" (184 mm)	1 3/4" (44 mm) Square	34" (864 mm)
All 5360V-38	7 1/4" (184 mm)	19 1/2" (495 mm)	11 1/4" (286 mm)	1 3/4" (44 mm) Square	38" (965 mm)
All 5360V-42	7 1/4" (184 mm)	19 1/2" (495 mm)	15 1/4" (387 mm)	1 3/4" (44 mm) Square	42" (1067 mm)
LJ-5370	1 3/4" (44 mm)	Round x 34" (864 mm)	38" (965 mm), or 42" (1067 mm)		
LJF-5370-34	7" (178 mm)	20" (508 mm)	7" (178 mm)	1 3/4" (44 mm) Round	34" (864 mm)
LJF-5370-38	7" (178 mm)	20" (508 mm)	11" (279 mm)	1 3/4" (44 mm) Round	38" (965 mm)
LJF-5370-42	7" (178 mm)	20" (508 mm)	15" (381 mm)	1 3/4" (44 mm) Round	42" (1067 mm)

Newel Posts:	Top Block	Detail Length	Bottom Block	Square Size	Overall Length
LJ-4000	N/A	N/A	N/A	3 1/2" (89 mm)	48" (1219 mm)
LJF-4000	1 1/2" (39 mm)	20" (508 mm)	16 1/2" (419 mm)	3 1/2" (89 mm)	48" (1219 mm)
LJC-4000	1 1/2" (39 mm)	20" (508 mm)	16 1/2" (419 mm)	3 1/2" (89 mm)	48" (1219 mm)

Intermediate Landing Newels	Top Block	Detail Length	Bottom Block	Square Size	Overall Length
LJ-4001	N/A	N/A	N/A	3 1/2" (89 mm)	58" (1473 mm)
LJF-4001	15" (381 mm)	16" (406 mm)	27" (686 mm)	3 1/2" (89 mm)	58" (1473 mm)
LJC-4001	15" (381 mm)	16" (406 mm)	27" (686 mm)	3 1/2" (89 mm)	58" (1473 mm)



Crisp Collection

Handrails and Square Balusters

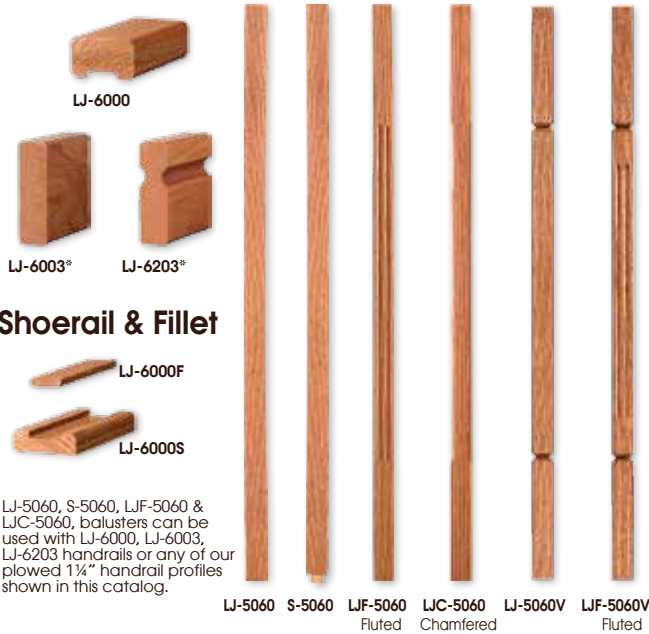

Shoerail & Fillet



LJ-5060, S-5060, LJF-5060 & LJC-5060, balusters can be used with LJ-6000, LJ-6003, LJ-6203 handrails or any of our plowed 1 1/4" handrail profiles shown in this catalog.

*This rail profile is used when the balusters will be side mounted to the handrail.

Non-Plowed Handrails and Round Balusters

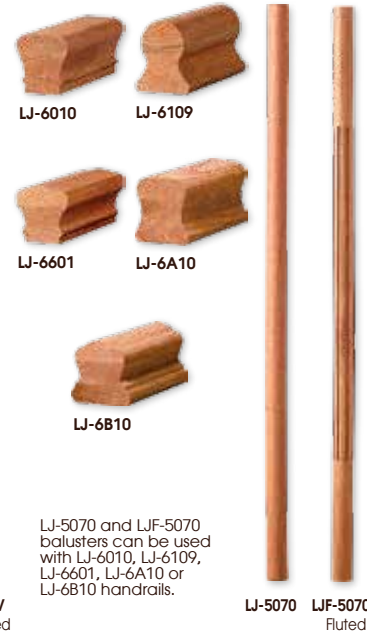

LJ-5070 and LJF-5070 balusters can be used with LJ-6010, LJ-6109, LJ-6601, LJ-6A10 or LJ-6B10 handrails.

NOTE: The balusters on this page are not pre-drilled, nor do they come with a ("Pin E-Z").

Newel Posts



Note: The balusters shown on this page can also be used with any other newel style shown in this catalog.

The handrail must be drilled with a 1 1/4" diameter hole to properly install the LJ-5070 or LJF-5070 balusters.

Post to Post

Product Dimensions					
Handrails:	Height	Profile Width	Bottom Width	Plow Width	
LJ-6000	1 1/4" (41 mm)	2 3/4" (70 mm)	2 3/4" (70 mm)	1 1/4" (32 mm)	
LJ-6003	5/8" (140 mm)	1 1/4" (41 mm)	1 1/4" (41 mm)	N/A	
LJ-6010	2 1/4" (60 mm)	2 1/4" (67 mm)	1 1/2" (38 mm)	N/A	
LJ-6109	2 1/4" (73 mm)	1 1/4" (48 mm)	2 3/8" (60 mm)	N/A	
LJ-6203	5/8" (140 mm)	1 1/4" (41 mm)	1 1/4" (41 mm)	N/A	
LJ-6601	2 1/4" (67 mm)	2 1/4" (67 mm)	1 1/2" (38 mm)	N/A	
LJ-6A10	2 3/8" (60 mm)	2" (51 mm)	2 1/4" (64 mm)	N/A	
LJ-6B10	2 3/8" (59 mm)	2" (51 mm)	2 3/8" (60 mm)	N/A	
Shoerail and Fillet:	Height	Width	Plow Width		
LJ-6000F	3/16" (8 mm)	1 1/4" (32 mm)		N/A	
LJ-6000S	3/4" (19 mm)	2 1/2" (64 mm)		1 1/4" (32 mm)	
Balusters:	Top Block	Detail Length	Bottom Block	Square Size	Overall Length
LJ-5060		1 1/4" (32 mm)	Square x 34" (864 mm), 38" (965 mm), or 42" (1067 mm)		
S-5060		1 1/4" (32 mm)	Square x 31" (787 mm), 34" (864 mm), 36" (914 mm), 39" (990 mm), or 42" (1067 mm)		
LJF-5060-34	7" (178 mm)	20" (508 mm)	7" (178 mm)	1 1/4" (32 mm) Square	34" (864 mm)
LJF-5060-38	7" (178 mm)	20" (508 mm)	11" (279 mm)	1 1/4" (32 mm) Square	38" (965 mm)
LJF-5060-42	7" (178 mm)	20" (508 mm)	15" (381 mm)	1 1/4" (32 mm) Square	42" (1067 mm)
LJC-5060-34	5 1/4" (149 mm)	18 1/2" (460 mm)	10" (254 mm)	1 1/4" (32 mm) Square	34" (864 mm)
LJC-5060-38	5 1/4" (149 mm)	18 1/2" (460 mm)	14" (356 mm)	1 1/4" (32 mm) Square	38" (965 mm)
LJC-5060-42	5 1/4" (149 mm)	18 1/2" (460 mm)	18" (457 mm)	1 1/4" (32 mm) Square	42" (1067 mm)
All 5060V-34	7 1/4" (184 mm)	19 1/2" (495 mm)	7 1/4" (184 mm)	1 1/4" (32 mm) Square	34" (864 mm)
All 5060V-38	7 1/4" (184 mm)	19 1/2" (495 mm)	11 1/4" (286 mm)	1 1/4" (32 mm) Square	38" (965 mm)
All 5060V-42	7 1/4" (184 mm)	19 1/2" (495 mm)	15 1/4" (387 mm)	1 1/4" (32 mm) Square	42" (1067 mm)
LJ-5070		1 1/4" (32 mm)	Round x 34" (864 mm), 38" (965 mm), or 42" (1067 mm)		
LJF-5070-34	7" (178 mm)	20" (508 mm)	7" (178 mm)	1 1/4" (32 mm) Round	34" (864 mm)
LJF-5070-38	7" (178 mm)	20" (508 mm)	11" (279 mm)	1 1/4" (32 mm) Round	38" (965 mm)
LJF-5070-42	7" (178 mm)	20" (508 mm)	15" (381 mm)	1 1/4" (32 mm) Round	42" (1067 mm)
Newel Posts:	Top Block	Detail Length	Bottom Block	Square Size	Overall Length
Utility Newels					
LJ-4110	N/A	N/A	N/A	3" (76 mm)	48" (1219 mm)
LJF-4110	11 1/2" (292 mm)	20" (508 mm)	16 1/2" (419 mm)	3" (76 mm)	48" (1219 mm)
LJC-4110	11 1/2" (292 mm)	20" (508 mm)	16 1/2" (419 mm)	3" (76 mm)	48" (1219 mm)
Intermediate Landing Newels					
LJ-4111	N/A	N/A	N/A	3" (76 mm)	58" (1473 mm)
LJF-4111	15" (381 mm)	16" (406 mm)	27" (686 mm)	3" (76 mm)	58" (1473 mm)
LJC-4111	15" (381 mm)	16" (406 mm)	27" (686 mm)	3" (76 mm)	58" (1473 mm)



Pictured: Our Crisp Collection Balusters can be combined with any of our newel posts. This stairway features our LJ-5060 Balusters with LJ-4075 Box Newels, and LJ-6000 Handrail.

Heirloom Collection

Post to Post

This section features our collection of box newels and decorative accessories—we call this our Heirloom Collection. The styling of these handcrafted posts dates back to the seventeenth and eighteenth centuries and is once again becoming a popular choice for many of today's homes.

Pictured: LJ-6010P Plowed Handrail, LJ-5060 Balusters, and LJ-4091NC Box Newels with LJ-C4091 Cap.

L.J. Smith Box Newels are individually hand made by experienced craftsmen, consistent with the methods and techniques that have been proven over many years. The next several pages feature our complete Box Newel offering, including our full line of decorative box newel accessories.



Pictured left to right:

LJ-4091 Box Newels, LI-1BASK44 and LI-DBLTW44 Iron Balusters, LJ-6519 Handrail.

LJRA-4091 Box Newels, LI-2TW44 LI-1BASK44, and LI-30144 Iron Balusters, LJ-6900 Handrail.

LJ-4091 Box Newels, LJ-5360 Balusters, LJ-6400P Handrail.

LJ-4095 Box Newels with LJ-9100 Rosette Blocks and LJ-9003 Acorn Finials, LJ-53008 Balusters, LJ-6701 Handrail.

The Box Newels shown here are our Traditional Style Box Newels. The construction of these newels allow for various installation methods. We recommend these newels be used with any of our iron or 1 3/4" (44 mm) balusters and corresponding handrails. They can, however, be used with 1 1/4" (32 mm) balusters and corresponding handrails. These newels can also be accessorized with our top plates and finials, as shown on page 41. All Box Newels and accessories are for interior use only.

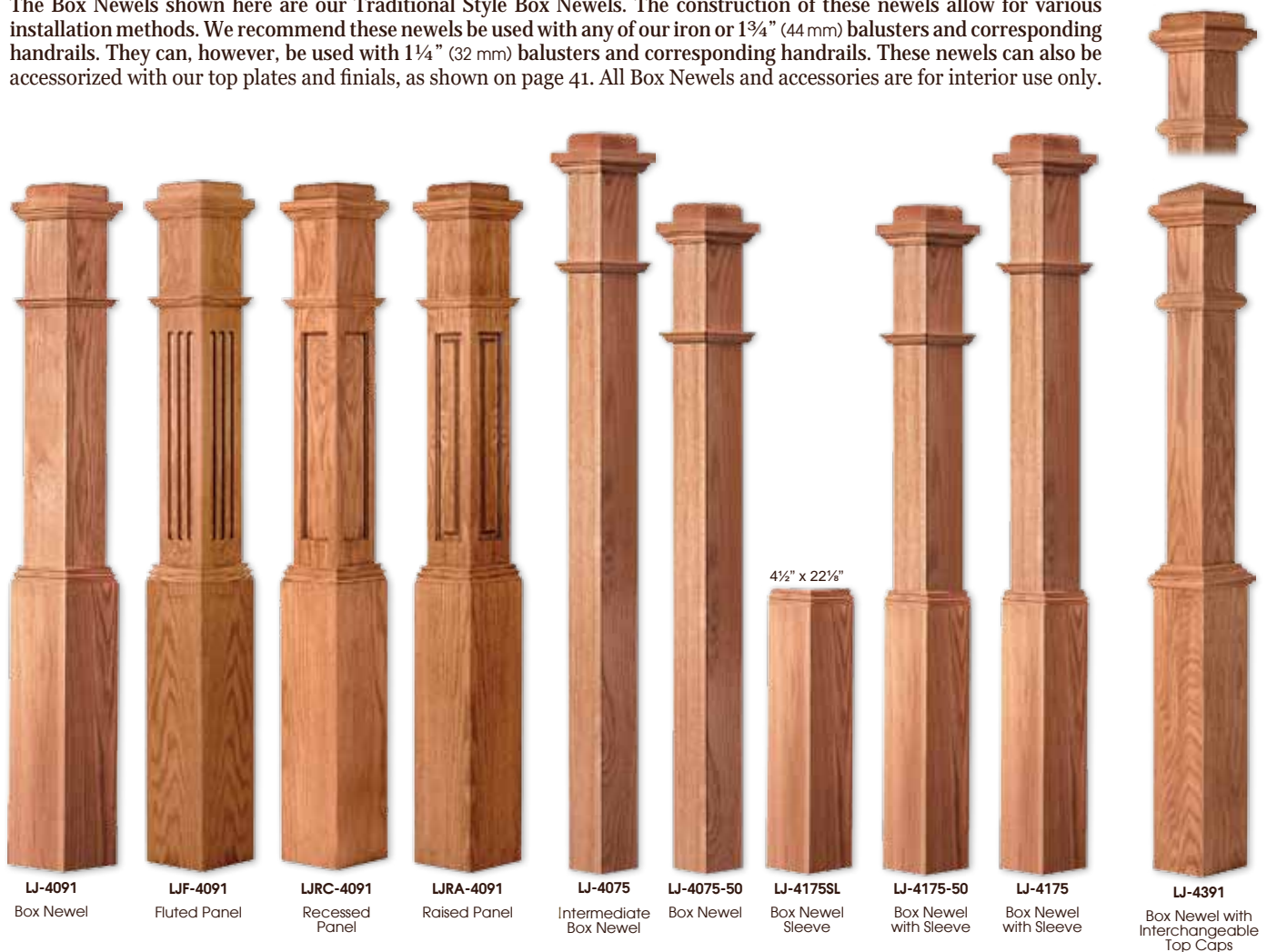

Product Dimensions									
Item Number:	Top Plate Height	Top Moulding Height	Middle Moulding Height	Bottom Moulding Height	Top Block Length	Center Length	Bottom Block Length	Square Size	Overall Length
All 4091's	1 3/8" (35 mm)	1 1/2" (38 mm)	3/4" (19 mm)	1 3/8" (35 mm)	6 1/4" (159 mm)	20 3/4" (527 mm)	23" (584 mm)	6 1/4" (159 mm)	55" (1397 mm)
LJ-4075	1 3/8" (35 mm)	1 1/2" (38 mm)	3/4" (19 mm)	N/A	6 1/4" (159 mm)	N/A	46 7/8" (1191 mm)	3 1/2" (89 mm)	56" (1422 mm)
LJ-4075-50	1 3/8" (35 mm)	1 1/2" (38 mm)	3/4" (19 mm)	N/A	6 1/4" (159 mm)	N/A	40 1/8" (1019 mm)	3 1/2" (89 mm)	50" (1270 mm)
LJ-4175	1 3/8" (35 mm)	1 1/2" (38 mm)	3/4" (19 mm)	N/A	6 1/4" (159 mm)	23 3/4" (603 mm)	22 1/2" (562 mm)	4 1/2" (114 mm)	56" (1422 mm)
LJ-4175-50	1 3/8" (35 mm)	1 1/2" (38 mm)	3/4" (19 mm)	N/A	6 1/4" (159 mm)	17 3/8" (448 mm)	22 1/2" (562 mm)	4 1/2" (114 mm)	50" (1270 mm)
LJ-4391	1 3/8" (35 mm) & 1 3/4" (19 mm)	1 7/8" (48 mm)	1 1/2" (38 mm)	1 7/8" (48 mm)	5 1/4" (133 mm)	22 3/4" (568 mm)	23 1/4" (591 mm)	5 1/2" (140 mm)	54 1/4" (1378 mm)

Each LJ-4391 Box Newel comes with two loose Top Caps for creating the desired look. The chosen cap is easily installed using construction adhesive and the provided wood pin.



Heirloom Collection

The construction of these box newels allows for various installation methods...each features a solid blocking within the top section while the remainder of the newel is hollow. We recommend these newels be used with any of our iron or 1 3/4" (44 mm) wood balusters and corresponding handrails. They can, however, also be used with 1 1/4" (32 mm) balusters and corresponding handrails. These newels can also be accessorized with our top plates and finials, as shown on page 41. All box newels and accessories are for interior use only.

BOX NEWELS



LJ-4092 Plain Panel LJ-4093 Fluted Panel LJ-4094 Recessed Panel LJ-4095 Raised Panel

INTERMEDIATE BOX NEWELS



LJ-4392† Plain Panel LJ-4393† Fluted Panel LJ-4394† Recessed Panel LJ-4395† Raised Panel

†Requires a gooseneck handrail fitting when used at an intermediate landing or second floor landing.

Product Dimensions

Item Number:	Top Moulding Height (includes flat top plate)	Middle Moulding Height	Bottom Moulding Height	Top Block Length	Center Length	Bottom Block Length	Square Size	Overall Length
LJ-4092	2 3/16" (56 mm)	1 1/4" (32 mm)	1 1/4" (32 mm)	5 3/16" (132 mm)	23 3/16" (592 mm)	20" (508 mm)	7 1/2" (191 mm)	53 3/16" (1351 mm)
LJ-4093	2 3/16" (56 mm)	1 1/4" (32 mm)	1 1/4" (32 mm)	5 3/16" (132 mm)	23 3/16" (592 mm)	20" (508 mm)	7 1/2" (191 mm)	53 3/16" (1351 mm)
LJ-4094	2 3/16" (56 mm)	1 1/4" (32 mm)	1 1/4" (32 mm)	5 3/16" (132 mm)	23 3/16" (592 mm)	20" (508 mm)	7 1/2" (191 mm)	53 3/16" (1351 mm)
LJ-4095	2 3/16" (56 mm)	1 1/4" (32 mm)	1 1/4" (32 mm)	5 3/16" (132 mm)	23 3/16" (592 mm)	20" (508 mm)	7 1/2" (191 mm)	53 3/16" (1351 mm)
LJ-4096*	2 3/16" (56 mm)	1 1/4" (32 mm)	1 1/4" (32 mm)	5 3/16" (132 mm)	23 3/16" (592 mm)	20" (508 mm)	7 1/2" (191 mm)	53 3/16" (1351 mm)
LJ-4097*	2 3/16" (56 mm)	1 1/4" (32 mm)	1 1/4" (32 mm)	5 3/16" (132 mm)	23 3/16" (592 mm)	20" (508 mm)	7 1/2" (191 mm)	53 3/16" (1351 mm)
LJ-4392	2 3/16" (56 mm)	1 1/4" (32 mm)	1 1/4" (32 mm)	5 3/16" (132 mm)	23 3/16" (592 mm)	28 13/16" (732 mm)	4 1/4" (108 mm)	62" (1575 mm)
LJ-4393	2 3/16" (56 mm)	1 1/4" (32 mm)	1 1/4" (32 mm)	5 3/16" (132 mm)	23 3/16" (592 mm)	28 13/16" (732 mm)	4 1/4" (108 mm)	62" (1575 mm)
LJ-4394	2 3/16" (56 mm)	1 1/4" (32 mm)	1 1/4" (32 mm)	5 3/16" (132 mm)	23 3/16" (592 mm)	28 13/16" (732 mm)	4 1/4" (108 mm)	62" (1575 mm)
LJ-4395	2 3/16" (56 mm)	1 1/4" (32 mm)	1 1/4" (32 mm)	5 3/16" (132 mm)	23 3/16" (592 mm)	28 13/16" (732 mm)	4 1/4" (108 mm)	62" (1575 mm)
LJ-4396*	2 3/16" (56 mm)	1 1/4" (32 mm)	1 1/4" (32 mm)	5 3/16" (132 mm)	23 3/16" (592 mm)	28 13/16" (732 mm)	4 1/4" (108 mm)	62" (1575 mm)
LJ-4397*	2 3/16" (56 mm)	1 1/4" (32 mm)	1 1/4" (32 mm)	5 3/16" (132 mm)	23 3/16" (592 mm)	28 13/16" (732 mm)	4 1/4" (108 mm)	62" (1575 mm)

* This item is pictured on the following page

These box newels feature decorative inlays for a more dramatic stairway appearance. Each of our Box Newels and Intermediate Box Newels can be ordered with either of the two inlay patterns installed, as shown below. These newels are identical in dimension, and are assembled in the same manner, as is our LJ-4092, LJ-4093, LJ-4094 and LJ-4095 series of box newels shown on the previous page. Our Inlaid Box Newels can be used with any of our wood or iron balusters and nearly all of our handrail profiles. These newels can also be accessorized with our top plates and finials, as shown on page 41.

SAMPLES OF BOX NEWEL/INLAY COMBINATIONS



LJ-4096-MW Maple Box Newel with Walnut Diamond & Trapezoid Inlay
LJ-4096-OO Oak Box Newel with Oak Diamond & Trapezoid Inlay
LJ-4097-OW Oak Box Newel with Walnut Rectangle Inlay
LJ-4097-OO Oak Box Newel with Oak Rectangle Inlay

SAMPLES OF INTERMEDIATE BOX NEWEL/INLAY COMBINATIONS



LJ-4396-MW† Maple Intermediate Box Newel with Walnut Diamond & Trapezoid Inlay
LJ-4396-OO† Oak Intermediate Box Newel with Oak Diamond & Trapezoid Inlay
LJ-4397-OW† Oak Intermediate Box Newel with Walnut Rectangle Inlay
LJ-4397-OO† Oak Intermediate Box Newel with Oak Rectangle Inlay

†Requires a gooseneck handrail fitting when used at an intermediate landing or second floor landing.

Species — Our Inlaid Box Newels are available in cherry (C), oak (O), and maple (M). The Inlays are available in the following wood species: cherry (C), walnut (W), oak (O), and maple (M). See page 17 for our wood species. When ordering Inlaid Box Newels, specify the Box Newel Item Number from the chart below and add a suffix of the Newel Specie code, followed by the Inlay Specie code. For example, LJ-4096-MW is a Maple Box Newel with Walnut Diamond & Trapezoid Inlay.

ITEM NUMBER	DESCRIPTION
LJ-4096	Box Newel with Diamond & Trapezoid Inlay
LJ-4097	Box Newel with Rectangle Inlay
LJ-4396	Intermediate Box Newel with Diamond & Trapezoid Inlay
LJ-4397	Intermediate Box Newel with Rectangle Inlay

Heirloom Collection

Our tapered box newel collection is carefully designed to be reminiscent of the early 1900s Arts and Crafts movement.



LJ-4000TP-4.5
LJ-4001TP-4.5

Solid

LJ-4091TP

Hollow

Product Dimensions

Item Number	Cap Height	Taper Length	Bottom Straight	Square Size	Overall Height
LJ-4000TP-4.5	2½" (64 mm)	28½" (724 mm)	17" (432 mm)	4½" (114 mm)	48" (1219 mm)
LJ-4001TP-4.5	2½" (64 mm)	28½" (724 mm)	27" (686 mm)	4½" (114 mm)	58" (1473 mm)
LJ-4091TP	2½" (64 mm)	32½" (813 mm)	23" (584 mm)	6¼" (159 mm)	58" (1473 mm)

L.J. Smith offers a versatile collection of newel options to create the perfect combination for stairways with painted balusters and stained handrail. Choose from five gloss primed newel styles and coordinating caps in the species to match the handrail and other woodwork in the home.



LJ-4110SQ-PRG
S4S 3" x 48"

LJ-4000SQ-PRG
S4S 3½" x 48"

LJ-4075NC-PRG
LJ-4075
without cap

LJ-4091NC-PRG
LJ-4091
without cap

LJF-4091NC-PRG
LJF-4091
without cap

LJ-4111SQ-PRG
S4S 3" x 58"

LJ-4001SQ-PRG
S4S 3½" x 58"

Product Dimensions

	Item Number	Width	Height
Top Caps:	LJ-9011	4½" (114 mm)	1¾" (41 mm)
	LJ-9012	5¼" (138 mm)	1¾" (41 mm)
	LJ-C4075	5" (127 mm)	2¼" (73 mm)
	LJ-C4091	6¼" (158 mm)	2¾" (73 mm)
Newel Bodies:	Item Number	Width	Height
	LJ-4110SQ	3" (76 mm)	48" (1219 mm)
	LJ-4111SQ	3" (76 mm)	58" (1473 mm)
	LJ-4000SQ	3½" (89 mm)	48" (1219 mm)
	LJ-4001SQ	3½" (89 mm)	58" (1473 mm)
	LJ-4075NC	3½" (89 mm)	54¾" (1381 mm)
	LJ-4091NC	6¼" (159 mm)	53¾" (1355 mm)
LJF-4091NC	6¼" (159 mm)	53¾" (1355 mm)	



Our decorative metal newel caps are designed to fit 3", 3 1/4" and 3 1/2" square wood posts. This combination is perfect for multiple home designs such as Contemporary, Retro, Modern, Craftsman, etc. and blends well with our wide array of iron balusters. Installation is simple using only construction adhesive.



Shown in Matte Nickel

Shown in Oil Rubbed Copper

Shown in Satin Black

Shown in Stainless Steel

LJ-9017-3.0
3" Newel Cap

LJ-9017-3.25
3 1/4" Newel Cap

LJ-9017-3.50
3 1/2" Newel Cap

LJ-9018-3.0
3" Newel Cap

LJ-9018-3.25
3 1/4" Newel Cap

LJ-9018-3.50
3 1/2" Newel Cap



Item Number	Satin Black (SB)	Low Sheen Black (LSB)	Matte Nickel (MN)	Oil Rubbed Copper (ORC)	Stainless Steel (SS)
LI-9017-3.0	✓	✓	✓	✓	✓
LI-9017-3.25	✓	✓	✓	✓	✓
LI-9017-3.50	✓	✓	✓	✓	✓
LI-9018-3.0	✓	✓	✓	✓	✓
LI-9018-3.25	✓	✓	✓	✓	✓
LI-9018-3.50	✓	✓	✓	✓	✓

See page 56 for finish samples. NOTE: Finishes may vary.

Easily upgrade any half wall stairway with our innovative Half Wall Box Newel and Sleeve. This very economical stairway upgrade is great for new construction and remodel work. Designed for a standard 4-9/16" wall (2x4 & 1/2" drywall construction). Available in matte primed finish to be painted to match the walls or trim in the home. For interior use only.



LJ-4098
Half Wall Box Newel

LJ-4098SL
Half Wall Box Newel Sleeve



Quick and Simple Installation!



1 - Trim newel and sleeve



2 - Slide newel onto half wall



3 - Secure newel in place

Product Dimensions

Item Number:	Top Cap Height	Top Block Length	Middle Moulding Height	Bottom Newel Length	Square Size	Overall Length	Opening Height	Opening Width
LJ-4098	2 7/8" (73 mm)	6 1/2" (165 mm)	3/4" (19 mm)	44 7/8" (1139 mm)	6 1/4" (155 mm)	55" (1397 mm)	49 7/8" (1260 mm)	4 3/8" (117 mm)
LJ-4098SL	N/A	N/A	N/A	N/A	7 7/8" (194 mm)	23" (584 mm)	23" (584 mm)	4 3/8" (117 mm)

Heirloom Collection Accessories

Post to Post

Many of our Box Newels are crafted with a flat top plate. This allows for a variety of options from which you can choose to suit your particular taste. Each of the items pictured below are sold separately and are available in the same wood species as our Box Newels. All Box Newels and accessories are for interior use only.

Top Plates — Our Flat Top Plates and Chamfered Top Plates can be added directly to our Box Newels for added dimension.



Finial — Finials are a very early form of architectural ornamentation of stairways in the world's finest homes. A finial can be applied directly to our standard box newel top or the LJ-9000/LJ-9300 Flat Top (as pictured below). Each finial is shipped with a 2½" x 5/16" lag screw.



Product Dimensions

	Item Number	Length	Width	Thickness
Top Plates:	LJ-9000	5" (127 mm)	5" (127 mm)	1" (25 mm)
	LJ-9001	5" (127 mm)	5" (127 mm)	1 ¼" (32 mm)
	LJ-9300	3 ¾" (92 mm)	3 ¾" (92 mm)	¾" (22 mm)
	LJ-9301	3 ¾" (92 mm)	3 ¾" (92 mm)	1 5/16" (24 mm)
Finial:	LJ-9008	4 7/8" (113 mm)	3 ¼" (83 mm)	3 7/8" (98 mm)

The following chart shows which accessories (listed along the left side) can be used with each of our box newels (listed across the top).

	4075	4091	4092	4093	4094	4095	4096	4097	4175	4391	4392	4393	4394	4395	4396	4397
9000			✓	✓	✓	✓	✓	✓								
9001			✓	✓	✓	✓	✓	✓								
9008		✓	✓	✓	✓	✓	✓	✓		✓	✓	✓	✓	✓	✓	✓
9300											✓	✓	✓	✓	✓	✓
9301											✓	✓	✓	✓	✓	✓



Pictured: Custom Handrail, LIH-HOL166244 & LIH-HOLPLA44 Iron Balusters, and LJ-4091 Box Newel.



Pictured: LJ-6900P Plowed Handrail, LJ-5360 Balusters, and Custom LJ-4094 Box Newel.

Over the Post Systems

This section features all of our wood Over the Post Balustrade options. Each collection pictures components that are compatible with one another. We recommend choosing the handrail, baluster and newel styles for your stairway from the same collection.

Over the Post



Pictured: LJ-6900 Handrail, LJP-2915 Balusters, LJP-3910 Newel Series and LJ-7930 Left Hand Volute.

Harbor Collection

Non-Plowed Handrails and Pin Top Balusters



2915 balusters can be used with LJ-6109, LJ-6210, LJ-6400, LJ-6519, LJ-6701, LJ-6900, LJ-6A10 or LJ-6B10 handrails.



Shoerail & Fillet



Plowed Handrails and Square Top Balusters



2905 balusters can be used with LJ-6109P1, LJ-6210P, LJ-6400P, LJ-6519P, LJ-6900P, LJ-6A10P1 or LJ-6B10P1 handrails.



Balusters on this page are pre-drilled with a 9/32" (7 mm) diameter hole at least 3" (76 mm) deep in which a pin ("Pin E-Z") is loosely inserted. Every baluster can then be installed in the traditional manner, or by using the Dowel-Fast™ screws as shown on page 85 (sold separately).

Product Dimensions

Handrails:	Height	Profile Width	Bottom Width	Plow Width	
LJ-6109	2 1/4" (73 mm)	1 3/8" (48 mm)	2 3/8" (60 mm)	N/A	
LJ-6109P1	2 1/8" (73 mm)	1 7/8" (48 mm)	2 3/8" (60 mm)	1 3/4" (44 mm)	
LJ-6210	2 3/8" (60 mm)	2 3/8" (67 mm)	2" (51 mm)	N/A	
LJ-6210P	2 3/8" (60 mm)	2 3/8" (67 mm)	2" (51 mm)	1 3/4" (44 mm)	
LJ-6400	2 1/4" (57 mm)	2 3/4" (70 mm)	3" (76 mm)	N/A	
LJ-6400P	2 1/4" (57 mm)	2 3/4" (70 mm)	3" (76 mm)	1 3/4" (44 mm)	
LJ-6519	3" (76 mm)	2 5/8" (67 mm)	2 5/8" (67 mm)	N/A	
LJ-6519P	3" (76 mm)	2 5/8" (67 mm)	2 5/8" (67 mm)	1 3/4" (44 mm)	
LJ-6701	2 1/8" (54 mm)	2 3/4" (70 mm)	1 5/8" (41 mm)	N/A	
LJ-6900	2 3/4" (70 mm)	2 5/8" (67 mm)	1 13/16" (49 mm)	N/A	
LJ-6900P	2 3/4" (70 mm)	2 5/8" (67 mm)	1 13/16" (49 mm)	1 3/4" (44 mm)	
LJ-6A10	2 3/8" (60 mm)	2" (51 mm)	2 1/8" (54 mm)	N/A	
LJ-6A10P1	2 3/8" (60 mm)	2" (51 mm)	2 1/8" (54 mm)	1 3/4" (44 mm)	
LJ-6B10	2 3/8" (59 mm)	2" (51 mm)	2 3/8" (60 mm)	N/A	
LJ-6B10P1	2 3/8" (59 mm)	2" (51 mm)	2 3/8" (60 mm)	1 3/4" (44 mm)	
Shoerail and Fillet:	Height	Width	Plow Width		
LJ-6006	1" (25 mm)	3 1/8" (79 mm)	1 3/4" (44 mm)		
LJ-6007	3/4" (19 mm)	1 3/4" (44 mm)	N/A		
Balusters:	Top Block	Turning Length	Bottom Block	Square Size	Overall Length
2905-34	6 1/2" (165 mm)	21 1/16" (535 mm)	6 7/16" (164 mm)	1 3/4" (44 mm)	34" (864 mm)
2905-38	6 1/2" (165 mm)	21 1/16" (535 mm)	10 1/16" (265 mm)	1 3/4" (44 mm)	38" (965 mm)
2905-42	6 1/2" (165 mm)	21 1/16" (535 mm)	14 7/16" (367 mm)	1 3/4" (44 mm)	42" (1067 mm)
2915-34	N/A	27 7/16" (700 mm)	6 7/16" (164 mm)	1 3/4" (44 mm)	34" (864 mm)
2915-38	N/A	27 7/16" (700 mm)	10 1/16" (265 mm)	1 3/4" (44 mm)	38" (965 mm)
2915-42	N/A	27 7/16" (700 mm)	14 7/16" (367 mm)	1 3/4" (44 mm)	42" (1067 mm)
Newel Posts:	Turning Length	Bottom Block	Square Size	Overall Length	
Utility Newels					
3910	23 3/16" (586 mm)	18 13/16" (481 mm)	3 1/4" (83 mm)	43" (1092 mm)	
3914	23 3/16" (586 mm)	25 3/16" (639 mm)	3 1/4" (83 mm)	50" (1270 mm)	
Intermediate Landing Newel					
3915	23 3/16" (586 mm)	33 13/16" (862 mm)	3 1/4" (83 mm)	58" (1473 mm)	
3918	23 3/16" (586 mm)	48 13/16" (1243 mm)	3 1/4" (83 mm)	73" (1854 mm)	

* Length is from the top of the bottom block to the top of the baluster



Newel Posts



LJB-3910
LJB-3914
LJB-3915
LJB-3918
Beaded



LJF-3910
LJF-3914
LJF-3915
LJF-3918
Fluted



LJP-3910
LJP-3914
LJP-3915
LJP-3918

Newel Drop



LJ-4099A

Consider iron newels for your stairway from our Iron Collection on page 68

Iron Newels

Over the Post



Pictured Left: LJ-6400 Handrail, LJF-3910 Utility Newels, LJF-2915 Balusters, LJ-7430 Left Hand Volute, LJ-7441-90 Left Hand Turnout and LJ-7446-90 Right Hand Turnout.

Pictured Above: LJ-6900 Handrail, LJ-6900B Bending Handrail, LJP-3910 Utility Newels and LJP-2915 Balusters.

Briarcliffe Collection

Non-Plowed Handrails and Pin Top Balusters

Plowed Handrails and Square Top Balusters



2115 and LJ-2111 balusters can be used with LJ-6109, LJ-6210, LJ-6400, LJ-6519, LJ-6701, LJ-6900, LJ-6A10 or LJ-6B10 handrails.

Shoerail & Fillet

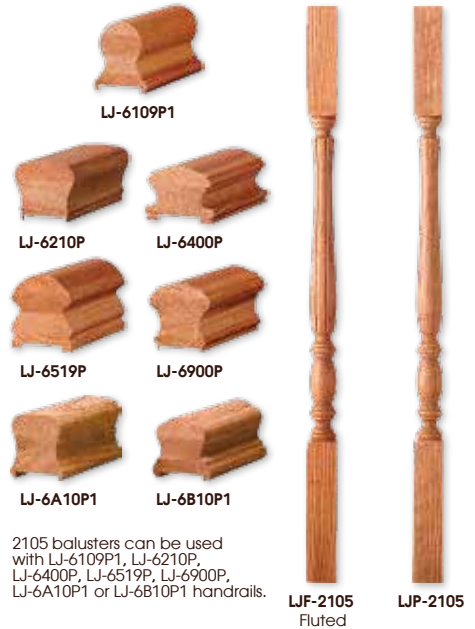

2105 balusters can be used with LJ-6109P1, LJ-6210P, LJ-6400P, LJ-6519P, LJ-6900P, LJ-6A10P1 or LJ-6B10P1 handrails.

Balusters on this page are pre-drilled with a 9/32" (7 mm) diameter hole at least 3" (76 mm) deep in which a pin ("Pin E-Z") is loosely inserted. Every baluster can then be installed in the traditional manner, or by using the Dowel-Fast™ screws as shown on page 85 (sold separately).

Product Dimensions

Handrails:	Height	Profile Width	Bottom Width	Plow Width
LJ-6109	2 1/4" (73 mm)	1 7/8" (48 mm)	2 3/4" (60 mm)	N/A
LJ-6109P1	2 1/4" (73 mm)	1 7/8" (48 mm)	2 3/4" (60 mm)	1 3/4" (44 mm)
LJ-6210	2 3/4" (60 mm)	2 3/4" (67 mm)	2" (51 mm)	N/A
LJ-6210P	2 3/4" (60 mm)	2 3/4" (67 mm)	2" (51 mm)	1 3/4" (44 mm)
LJ-6400	2 1/4" (67 mm)	2 3/4" (70 mm)	3" (76 mm)	N/A
LJ-6400P	2 1/4" (67 mm)	2 3/4" (70 mm)	3" (76 mm)	1 3/4" (44 mm)
LJ-6519	3" (76 mm)	2 3/4" (67 mm)	2 3/4" (67 mm)	N/A
LJ-6519P	3" (76 mm)	2 3/4" (67 mm)	2 3/4" (67 mm)	1 3/4" (44 mm)
LJ-6701	2 1/4" (64 mm)	2 3/4" (70 mm)	1 3/4" (41 mm)	N/A
LJ-6900	2 3/4" (70 mm)	2 3/4" (67 mm)	1 13/16" (49 mm)	N/A
LJ-6900P	2 3/4" (70 mm)	2 3/4" (67 mm)	1 13/16" (49 mm)	1 3/4" (44 mm)
LJ-6A10	2 3/4" (60 mm)	2" (51 mm)	2 1/4" (54 mm)	N/A
LJ-6A10P1	2 3/4" (60 mm)	2" (51 mm)	2 1/4" (54 mm)	1 3/4" (44 mm)
LJ-6B10	2 3/4" (59 mm)	2" (51 mm)	2 3/4" (60 mm)	N/A
LJ-6B10P1	2 3/4" (59 mm)	2" (51 mm)	2 3/4" (60 mm)	1 3/4" (44 mm)

Shoerail and Fillet:	Height	Width	Plow Width
LJ-6006	1" (25 mm)	3 1/4" (79 mm)	1 3/4" (44 mm)
LJ-6007	3/4" (19 mm)	1 3/4" (44 mm)	N/A

Balusters:	Top Block	Turning Length	Bottom Block	Square Size	Overall Length
2105-34	6 1/2" (165 mm)	19 1/2" (486 mm)	8 3/4" (213 mm)	1 3/4" (44 mm)	34" (864 mm)
2105-38	6 1/2" (165 mm)	19 1/2" (486 mm)	12 3/4" (314 mm)	1 3/4" (44 mm)	38" (965 mm)
2105-42	6 1/2" (165 mm)	19 1/2" (486 mm)	16 3/4" (416 mm)	1 3/4" (44 mm)	42" (1067 mm)
2111-34	N/A	25 3/4" (651 mm)	8 3/4" (213 mm)	1 3/4" (44 mm)	34" (864 mm)
2111-38	N/A	25 3/4" (651 mm)	12 3/4" (314 mm)	1 3/4" (44 mm)	38" (965 mm)
2111-42	N/A	25 3/4" (651 mm)	16 3/4" (416 mm)	1 3/4" (44 mm)	42" (1067 mm)
2115-34	N/A	25 7/16" (642 mm)	8 7/16" (214 mm)	1 3/4" (44 mm)	34" (864 mm)
2115-38	N/A	25 7/16" (642 mm)	12 7/16" (316 mm)	1 3/4" (44 mm)	38" (965 mm)
2115-42	N/A	25 7/16" (642 mm)	16 7/16" (418 mm)	1 3/4" (44 mm)	42" (1067 mm)

Newel Posts:	Turning Length	Bottom Block	Square Size	Overall Length
Utility Newels				
3310	22 1/4" (581 mm)	19 1/4" (486 mm)	3 1/2" (89 mm)	43" (1092 mm)
3314	22 1/4" (581 mm)	26 1/4" (664 mm)	3 1/2" (89 mm)	50" (1270 mm)
Intermediate Landing Newels				
3315	22 1/4" (581 mm)	34 1/4" (867 mm)	3 1/2" (89 mm)	58" (1473 mm)
3318	22 1/4" (581 mm)	49 1/4" (1248 mm)	3 1/2" (89 mm)	73" (1854 mm)

* Length is from the top of the bottom block to the top of the baluster



Newel Posts



LJF-3310
LJF-3314
LJF-3315
LJF-3318

Fluted



LJP-3310
LJP-3314
LJP-3315
LJP-3318

Newel Drop



LJ-4299A

Consider iron newels for your stairway from our Iron Collection on page 68

Iron Newels

Over the Post



Pictured: LJ-6210B Bending Handrail, LJP-3310 Utility Newel, LJ-2111 Balusters and LJ-7230 Left Hand Volute.

LaSalle Collection

Non-Plowed Handrails and Pin Top Balusters

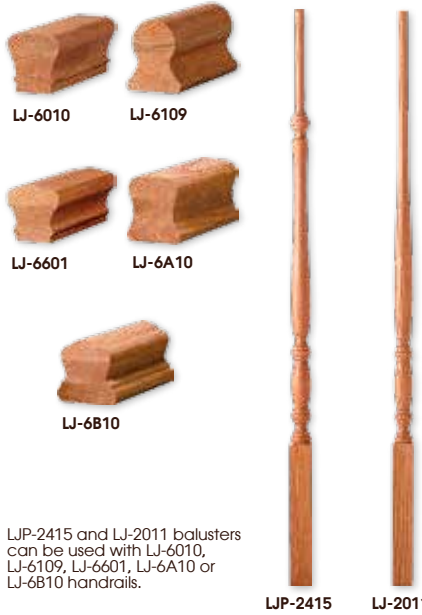

LJP-2415 and LJ-2011 balusters can be used with LJ-6010, LJ-6109, LJ-6601, LJ-6A10 or LJ-6B10 handrails.

Plowed Handrails and Square Top Balusters

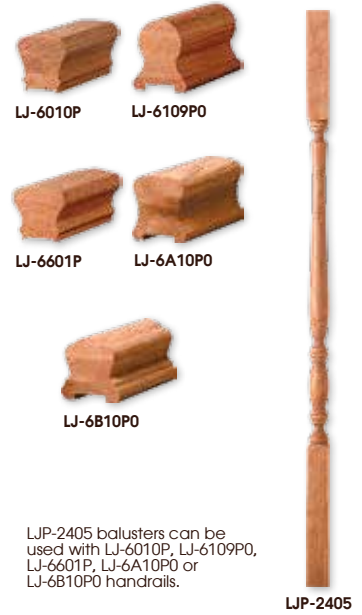

LJP-2405 balusters can be used with LJ-6010P, LJ-6109P0, LJ-6601P, LJ-6A10P0 or LJ-6B10P0 handrails.

Shoerail & Fillet



Over the Post

Balusters on this page are pre-drilled with a 9/32" (7 mm) diameter hole at least 3" (76 mm) deep in which a pin ("Pin E-Z") is loosely inserted. Every baluster can then be installed in the traditional manner, or by using the Dowel-Fast™ screws as shown on page 85 (sold separately).

Product Dimensions

Handrails:	Height	Profile Width	Bottom Width	Plow Width
LJ-6010	2 3/8" (60 mm)	2 1/4" (57 mm)	1 1/2" (38 mm)	N/A
LJ-6010P	2 3/8" (60 mm)	2 1/4" (57 mm)	1 1/2" (38 mm)	1 1/4" (32 mm)
LJ-6109	2 7/8" (73 mm)	1 3/4" (48 mm)	2 3/8" (60 mm)	N/A
LJ-6109P0	2 7/8" (73 mm)	1 3/4" (48 mm)	2 3/8" (60 mm)	1 1/4" (32 mm)
LJ-6601	2 1/4" (57 mm)	2 1/4" (57 mm)	1 1/2" (38 mm)	N/A
LJ-6601P	2 1/4" (57 mm)	2 1/4" (57 mm)	1 1/2" (38 mm)	1 1/4" (32 mm)
LJ-6A10	2 3/8" (60 mm)	2" (51 mm)	2 3/8" (60 mm)	N/A
LJ-6A10P0	2 3/8" (60 mm)	2" (51 mm)	2 3/8" (60 mm)	1 1/4" (32 mm)
LJ-6B10	2 3/8" (60 mm)	2" (51 mm)	2 3/8" (60 mm)	N/A
LJ-6B10P0	2 3/8" (60 mm)	2" (51 mm)	2 3/8" (60 mm)	1 1/4" (32 mm)

Shoerail and Fillet:	Height	Width	Plow Width
LJ-6045	3/4" (19 mm)	2 1/2" (64 mm)	1 1/4" (32 mm)
LJ-6050	3/8" (10 mm)	1 1/4" (32 mm)	N/A

Balusters:	Top Block	Turning Length	Bottom Block	Square Size	Overall Length
2011-34	N/A	25 9/16" (642 mm)	8 7/16" (214 mm)	1 1/4" (32 mm)	34" (864 mm)
2011-38	N/A	25 9/16" (642 mm)	12 7/16" (316 mm)	1 1/4" (32 mm)	38" (965 mm)
2011-42	N/A	25 9/16" (642 mm)	16 7/16" (418 mm)	1 1/4" (32 mm)	42" (1067 mm)
2405-34	6 1/2" (165 mm)	19 1/8" (486 mm)	8 3/8" (213 mm)	1 1/4" (32 mm)	34" (864 mm)
2405-38	6 1/2" (165 mm)	19 1/8" (486 mm)	12 3/8" (314 mm)	1 1/4" (32 mm)	38" (965 mm)
2405-42	6 1/2" (165 mm)	19 1/8" (486 mm)	16 3/8" (416 mm)	1 1/4" (32 mm)	42" (1067 mm)
2415-34	N/A	25 9/16" (642 mm)	8 7/16" (214 mm)	1 1/4" (32 mm)	34" (864 mm)
2415-38	N/A	25 9/16" (642 mm)	12 7/16" (316 mm)	1 1/4" (32 mm)	38" (965 mm)
2415-42	N/A	25 9/16" (642 mm)	16 7/16" (418 mm)	1 1/4" (32 mm)	42" (1067 mm)

Newel Posts:	Turning Length	Bottom Block	Square Size	Overall Length
Utility Newels				
3210	22 7/8" (581 mm)	19 1/8" (486 mm)	3" (76 mm)	43" (1092 mm)
3214	22 7/8" (581 mm)	26 1/8" (664 mm)	3" (76 mm)	50" (1270 mm)
Intermediate Landing Newels				
3215	22 7/8" (581 mm)	34 1/8" (867 mm)	3" (76 mm)	58" (1473 mm)
3218	22 7/8" (581 mm)	49 3/8" (1248 mm)	3" (76 mm)	73" (1854 mm)

* Length is from the top of the bottom block to the top of the baluster



Newel Posts



LJF-3210
LJF-3214
LJF-3215
LJF-3218

Fluted



LJP-3210
LJP-3214
LJP-3215
LJP-3218

Newel Drop



LJ-4099A

Consider iron newels for your stairway from our Iron Collection on page 68

Iron Newels

Over the Post



Pictured Above: LJ-6A10 Handrail, LJP-3210 Newel Series LJP-2415 Balusters, LJ-7A31 Left Hand Climbing Volute and LJ-7A36 Right Hand Climbing Volute.

Pictured Left: LJ-6B10 Handrail, LJF-3210 Newel Series LJF-2115 Balusters and LJ-7B30 Left Hand Volute.

Regent Collection

Non-Plowed Handrails and Pin Top Balusters

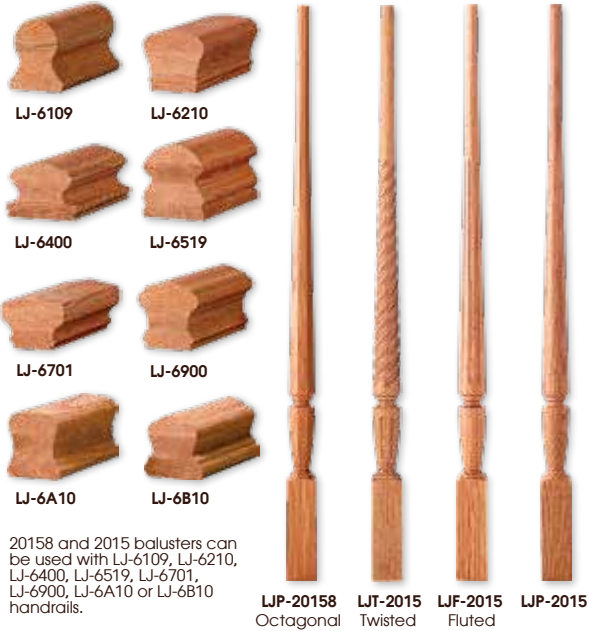

20158 and 2015 balusters can be used with LJ-6109, LJ-6210, LJ-6400, LJ-6519, LJ-6701, LJ-6900, LJ-6A10 or LJ-6B10 handrails.

Plowed Handrails and Square Top Balusters

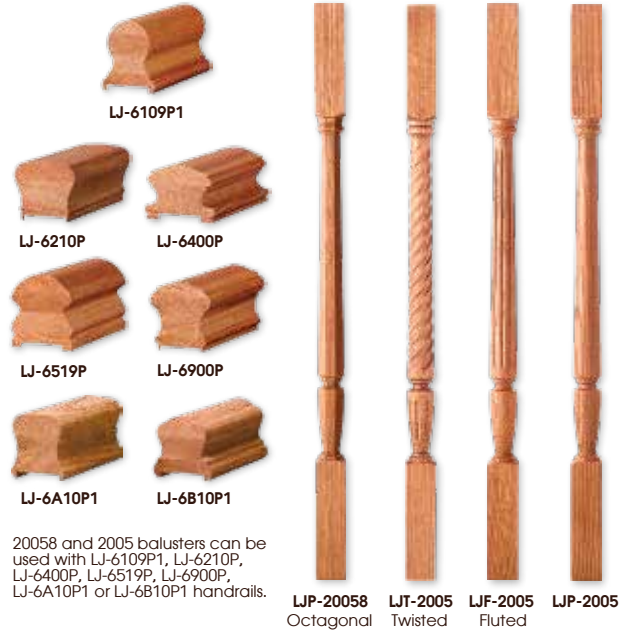

20058 and 2005 balusters can be used with LJ-6109P1, LJ-6210P, LJ-6400P, LJ-6519P, LJ-6900P, LJ-6A10P1 or LJ-6B10P1 handrails.

Shoerail & Fillet



Over the Post

Balusters on this page are pre-drilled with a 9/32"(7 mm) diameter hole at least 3"(76 mm) deep in which a pin ("Pin E-Z") is loosely inserted. Every baluster can then be installed in the traditional manner, or by using the Dowel-Fast™ screws as shown on page 85 (sold separately).

Product Dimensions

Handrails:	Height	Profile Width	Bottom Width	Plow Width
LJ-6109	2 1/4" (73 mm)	1 7/8" (48 mm)	2 3/8" (60 mm)	N/A
LJ-6109P1	2 1/4" (73 mm)	1 7/8" (48 mm)	2 3/8" (60 mm)	1 3/4" (44 mm)
LJ-6210	2 3/4" (60 mm)	2 3/8" (67 mm)	2" (51 mm)	N/A
LJ-6210P	2 3/4" (60 mm)	2 3/8" (67 mm)	2" (51 mm)	1 3/4" (44 mm)
LJ-6400	2 1/4" (57 mm)	2 3/4" (70 mm)	3" (76 mm)	N/A
LJ-6400P	2 1/4" (57 mm)	2 3/4" (70 mm)	3" (76 mm)	1 3/4" (44 mm)
LJ-6519	3" (76 mm)	2 3/8" (67 mm)	2 3/8" (67 mm)	N/A
LJ-6519P	3" (76 mm)	2 3/8" (67 mm)	2 3/8" (67 mm)	1 3/4" (44 mm)
LJ-6701	2 1/4" (54 mm)	2 3/4" (70 mm)	1 3/8" (41 mm)	N/A
LJ-6900	2 3/4" (70 mm)	2 3/8" (67 mm)	1 13/16" (49 mm)	N/A
LJ-6900P	2 3/4" (70 mm)	2 3/8" (67 mm)	1 13/16" (49 mm)	1 3/4" (44 mm)
LJ-6A10	2 3/8" (60 mm)	2" (51 mm)	2 1/8" (54 mm)	N/A
LJ-6A10P1	2 3/8" (60 mm)	2" (51 mm)	2 1/8" (54 mm)	1 3/4" (44 mm)
LJ-6B10	2 3/8" (59 mm)	2" (51 mm)	2 3/8" (60 mm)	N/A
LJ-6B10P1	2 3/8" (59 mm)	2" (51 mm)	2 3/8" (60 mm)	1 3/4" (44 mm)

Shoerail and Fillet:	Height	Width	Plow Width
LJ-6006	1" (25 mm)	3 1/8" (79 mm)	1 3/4" (44 mm)
LJ-6007	3/4" (8 mm)	1 3/4" (44 mm)	N/A

Balusters:	Top Block	Turning Length	Bottom Block	Square Size	Overall Length
2005(8)-34	7" (178 mm)	20" (508 mm)	7" (178 mm)	1 3/4" (44 mm)	34" (864 mm)
2005(8)-38	7" (178 mm)	20" (508 mm)	11" (279 mm)	1 3/4" (44 mm)	38" (965 mm)
2005(8)-42	7" (178 mm)	20" (508 mm)	15" (381 mm)	1 3/4" (44 mm)	42" (1067 mm)
2015(8)-34	N/A	28" (711 mm)	6" (152 mm)	1 3/4" (44 mm)	34" (864 mm)
2015(8)-38	N/A	28" (711 mm)	10" (254 mm)	1 3/4" (44 mm)	38" (965 mm)
2015(8)-42	N/A	28" (711 mm)	14" (356 mm)	1 3/4" (44 mm)	42" (1067 mm)

Newel Posts:	Turning Length	Bottom Block	Square Size	Overall Length
3010(8)	27" (686 mm)	15" (381 mm)	3 1/2" (89 mm)	43" (1092 mm)
3014(8)	27" (686 mm)	22" (559 mm)	3 1/2" (89 mm)	50" (1270 mm)

Intermediate Landing Newels	Turning Length	Bottom Block	Square Size	Overall Length
3015(8)	27" (686 mm)	30" (762 mm)	3 1/2" (89 mm)	58" (1473 mm)
3018(8)	27" (686 mm)	45" (1143 mm)	3 1/2" (89 mm)	73" (1854 mm)

* Length is from the top of the bottom block to the top of the baluster



Newel Posts



LJP-30108
LJP-30148
LJP-30158
LJP-30188
Octagonal



LJT-3010
LJT-3014
LJT-3015
LJT-3018
Twisted



LJF-3010
LJF-3014
LJF-3015
LJF-3018
Fluted



LJP-3010
LJP-3014
LJP-3015
LJP-3018

Newel Drop



LJ-4299A

Consider iron newels for your stairway from our Iron Collection on page 68

Iron Newels

Over the Post

Pictured Left: LJ-6400 Handrail, LJP-30108 Utility Newels, LJP-20158 Balusters, LJ-7430 Left Hand Volute and LJ-7435 Right Hand Volute.

Pictured Below: LJ-6210B Bending Handrail and LJP-2015 Balusters.

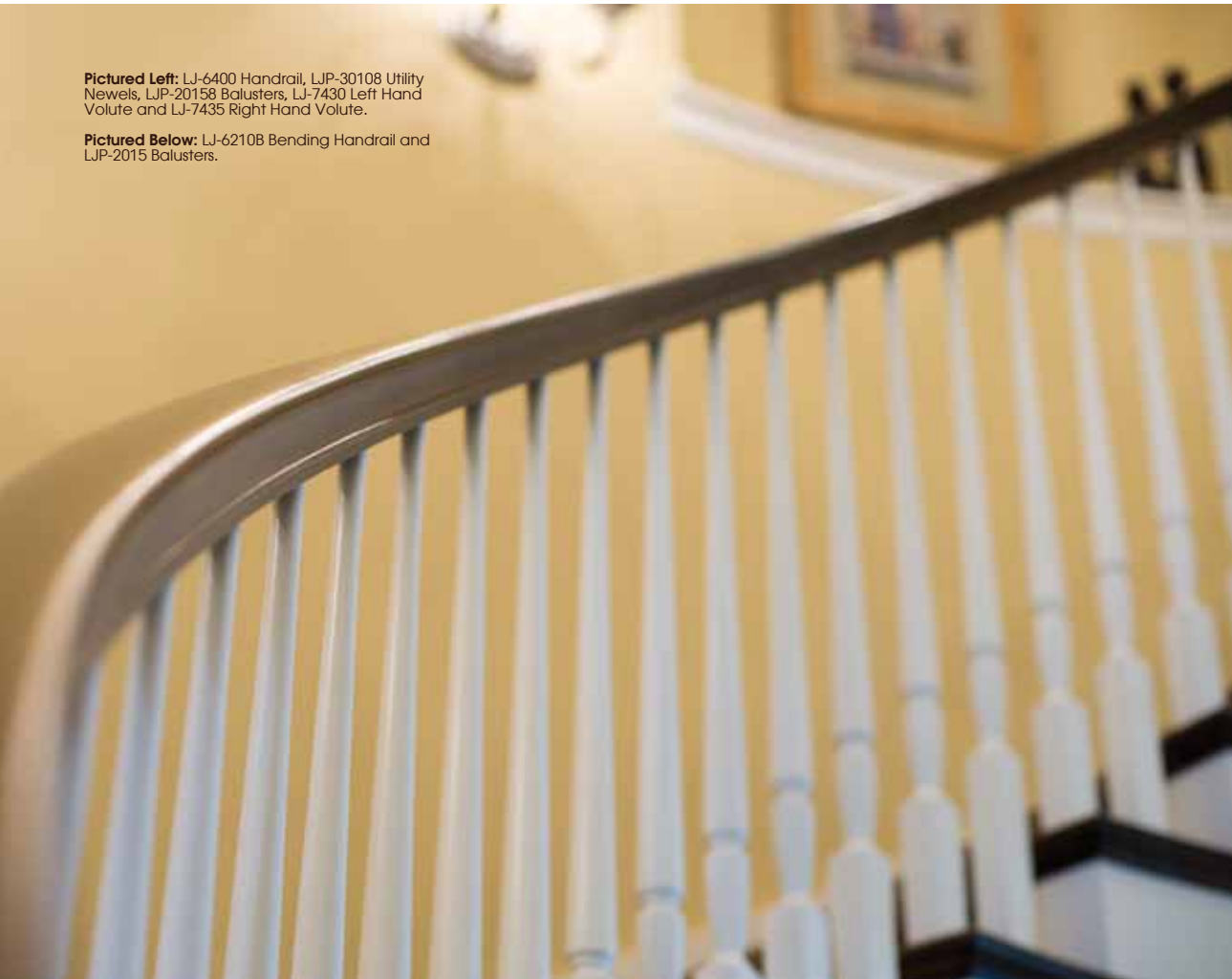

Pictured Above: LJ-6400P Handrail, LJF-3010 Utility Newel, LJF-2005 Balusters, LJ-7430 Left Hand Volute and LJ-7411 Quarterturn.

Harmony Collection

Non-Plowed Handrails and Pin Top Balusters



53008 and 5300 balusters can be used with LJ-6109, LJ-6210, LJ-6400, LJ-6519, LJ-6701, LJ-6900, LJ-6A10 or LJ-6B10 handrails.

Shoerail & Fillet



Plowed Handrails and Square Top Balusters

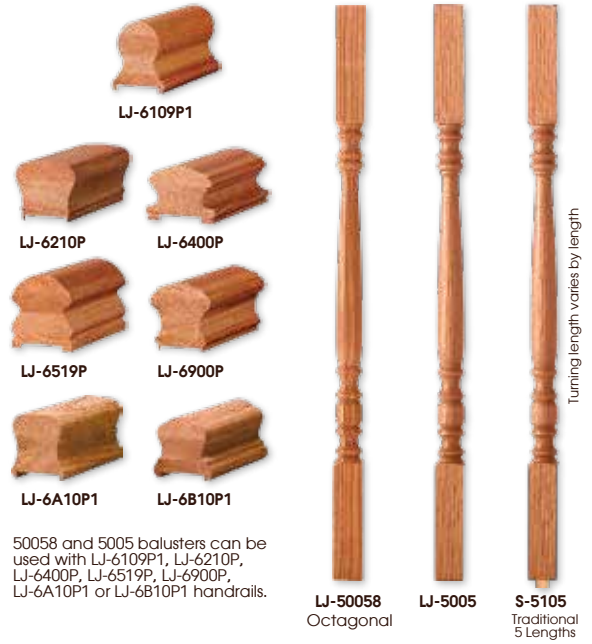

50058 and 5005 balusters can be used with LJ-6109P1, LJ-6210P, LJ-6400P, LJ-6519P, LJ-6900P, LJ-6A10P1 or LJ-6B10P1 handrails.

"LJ-" series balusters are pre-drilled with a 9/32" (7 mm) diameter hole at least 3" (76 mm) deep in which a pin ("Pin E-Z") is loosely inserted. The balusters can then be installed in the traditional manner, or by using the Dowel-Fast™ screws as shown on page 85 (sold separately). "S-" series balusters have a turned bottom pin.

Product Dimensions

Handrails:	Height	Profile Width	Bottom Width	Plow Width
LJ-6109	2 1/4" (73 mm)	1 1/4" (48 mm)	2 3/8" (60 mm)	N/A
LJ-6109P1	2 1/4" (73 mm)	1 1/4" (48 mm)	2 3/8" (60 mm)	1 3/4" (44 mm)
LJ-6210	2 3/8" (60 mm)	2 3/8" (67 mm)	2" (51 mm)	N/A
LJ-6210P	2 3/8" (60 mm)	2 3/8" (67 mm)	2" (51 mm)	1 3/4" (44 mm)
LJ-6400	2 1/4" (57 mm)	2 3/4" (70 mm)	3" (76 mm)	N/A
LJ-6400P	2 1/4" (57 mm)	2 3/4" (70 mm)	3" (76 mm)	1 3/4" (44 mm)
LJ-6519	3" (76 mm)	2 3/4" (67 mm)	2 3/8" (67 mm)	N/A
LJ-6519P	3" (76 mm)	2 3/4" (67 mm)	2 3/8" (67 mm)	1 3/4" (44 mm)
LJ-6701	2 1/4" (54 mm)	2 3/4" (70 mm)	1 3/4" (41 mm)	N/A
LJ-6900	2 3/4" (70 mm)	2 3/4" (67 mm)	1 13/16" (49 mm)	N/A
LJ-6900P	2 3/4" (70 mm)	2 3/4" (67 mm)	1 13/16" (49 mm)	1 3/4" (44 mm)
LJ-6A10	2 3/8" (60 mm)	2" (51 mm)	2 1/8" (54 mm)	N/A
LJ-6A10P1	2 3/8" (60 mm)	2" (51 mm)	2 1/8" (54 mm)	1 3/4" (44 mm)
LJ-6B10	2 3/8" (59 mm)	2" (51 mm)	2 3/8" (60 mm)	N/A
LJ-6B10P1	2 3/8" (59 mm)	2" (51 mm)	2 3/8" (60 mm)	1 3/4" (44 mm)

Shoerail and Fillet:	Height	Width	Plow Width
LJ-6006	1" (25 mm)	3 1/8" (79 mm)	1 3/4" (44 mm)
LJ-6007	3/4" (8 mm)	1 3/4" (44 mm)	N/A

Balusters:	Top Block	Turning Length	Bottom Block	Square Size	Overall Length
LJ-5005ND-31†	5 1/8" (149 mm)	16 3/4" (422 mm)	8 1/2" (216 mm)	1 3/4" (44 mm)	31" (787 mm)
LJ-5005(8)-34	7" (178 mm)	20" (508 mm)	7" (178 mm)	1 3/4" (44 mm)	34" (864 mm)
LJ-5005(8)-38	7" (178 mm)	20" (508 mm)	11" (279 mm)	1 3/4" (44 mm)	38" (965 mm)
LJ-5005(8)-42	7" (178 mm)	20" (508 mm)	15" (381 mm)	1 3/4" (44 mm)	42" (1067 mm)
S-5105-31	5 1/8" (149 mm)	16 3/4" (422 mm)	7 3/4" (197 mm)	1 3/4" (44 mm)	31" (787 mm)
S-5105-34	5 1/8" (149 mm)	19 3/8" (498 mm)	7 3/4" (197 mm)	1 3/4" (44 mm)	34" (864 mm)
S-5105-36	5 1/8" (149 mm)	21 1/2" (549 mm)	7 3/4" (197 mm)	1 3/4" (44 mm)	36" (914 mm)
S-5105-39	5 1/8" (149 mm)	24 3/8" (625 mm)	7 3/4" (197 mm)	1 3/4" (44 mm)	39" (991 mm)
S-5105-42	8 1/8" (206 mm)	25 3/8" (645 mm)	7 3/4" (197 mm)	1 3/4" (44 mm)	42" (1067 mm)
LJ-5300(8)-34	N/A	27" (686 mm)	7" (178 mm)	1 3/4" (44 mm)	34" (864 mm)
LJ-5300(8)-38	N/A	27" (686 mm)	11" (279 mm)	1 3/4" (44 mm)	38" (965 mm)
LJ-5300(8)-42	N/A	27" (686 mm)	15" (381 mm)	1 3/4" (44 mm)	42" (1067 mm)
S-5300-31	N/A	22 1/2" (572 mm)	7 3/4" (197 mm)	1 3/4" (44 mm)	31" (787 mm)
S-5300-34	N/A	25 1/2" (648 mm)	7 3/4" (197 mm)	1 3/4" (44 mm)	34" (864 mm)
S-5300-36	N/A	27 1/2" (698 mm)	7 3/4" (197 mm)	1 3/4" (44 mm)	36" (914 mm)
S-5300-39	N/A	30 1/2" (775 mm)	7 3/4" (197 mm)	1 3/4" (44 mm)	39" (991 mm)
S-5300-42	N/A	33 1/2" (851 mm)	7 3/4" (197 mm)	1 3/4" (44 mm)	42" (1067 mm)

* Length is from the top of the bottom block to the top of the baluster

† This baluster is for kneewall stairways only. It is NOT predrilled and does NOT include the Pin EZ.

Product Dimensions

Newel Posts:	Turning Length	Bottom Block	Square Size	Overall Length
Utility Newels				
LJ-4270(8)	27" (686 mm)	15" (381 mm)	3 1/4" (83 mm)	43" (1092 mm)
LJ-4274(8)	27" (686 mm)	22" (559 mm)	3 1/4" (83 mm)	50" (1270 mm)
Intermediate Landing Newels				
LJ-4275(8)	27" (686 mm)	30" (762 mm)	3 1/4" (83 mm)	58" (1473 mm)
LJ-4278(8)	27" (686 mm)	45" (1143 mm)	3 1/4" (83 mm)	73" (1854 mm)
Rake Newel				
LJ-3513PT	27 1/4" (706 mm)	20 3/8" (513 mm)	3" (76 mm)	48" (1219 mm)



Newel Posts



LJ-42708
LJ-42748
LJ-42758
LJ-42788

Octagonal



LJ-4270
LJ-4274
LJ-4275
LJ-4278



LJ-3513PT

Newel Drop



LJ-4099A

Consider iron newels for your stairway from our Iron Collection on page 68

Iron Newels

Over the Post

Pictured Below: LJ-6400P Handrail, LJ-4270 Newels, LJ-5005 Balusters, LJ-7431 Left Hand Climbing Volute and LJ-7436 Right Hand Climbing Volute.

Pictured Right: LJ-6400 Handrail, LJ-42708 Newel Series, LJ-53008 Balusters LJ-7430 Left Hand Volute and LJ-7435 Right Hand Volute.



Cornerstone Collection

Non-Plowed Handrails and Pin Top Balusters

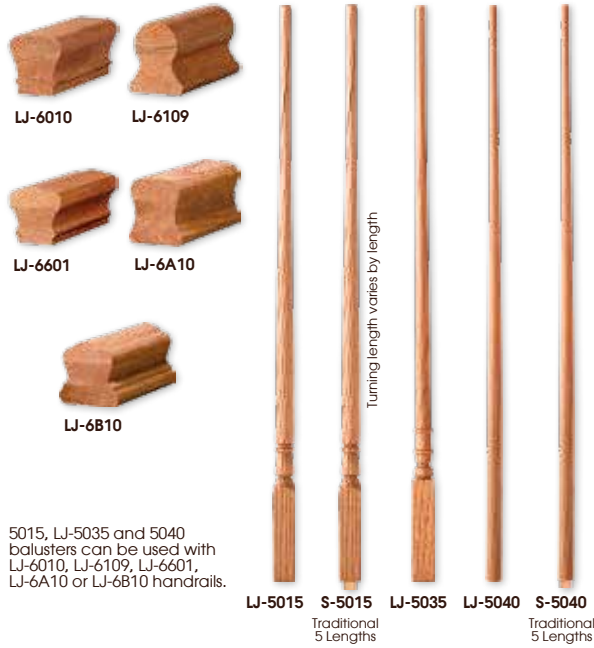

5015, LJ-5035 and 5040 balusters can be used with LJ-6010, LJ-6109, LJ-6601, LJ-6A10 or LJ-6B10 handrails.

Plowed Handrails and Square Top Balusters

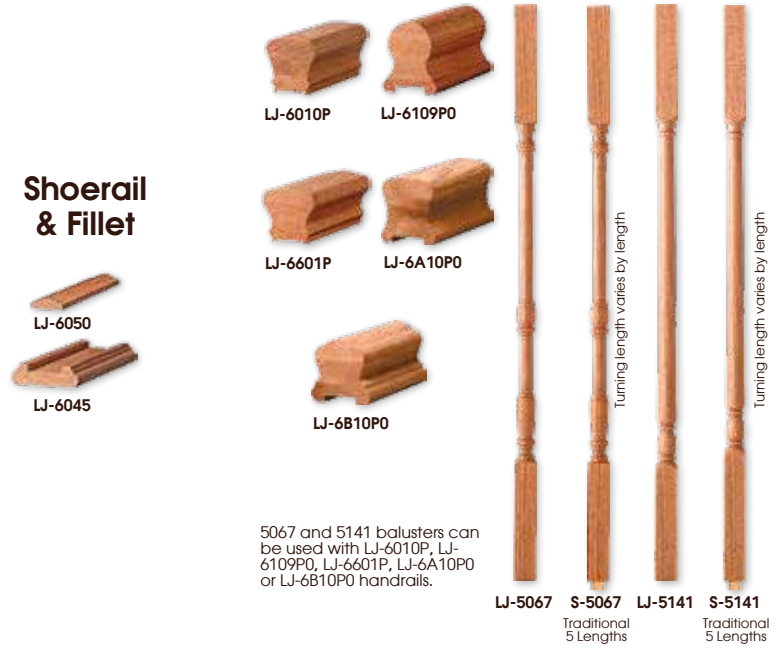

5067 and 5141 balusters can be used with LJ-6010P, LJ-6109P0, LJ-6601P, LJ-6A10P0 or LJ-6B10P0 handrails.

Shoerail & Fillet



Over the Post

"LJ-" series balusters are pre-drilled with a 9/32" (7 mm) diameter hole at least 3" (76 mm) deep in which a pin ("Pin E-Z") is loosely inserted. The balusters can then be installed in the traditional manner, or by using the Dowel-Fast™ screws as shown on page 85 (sold separately). "S-" series balusters have a turned bottom pin.

Product Dimensions

Handrails:	Height	Profile Width	Bottom Width	Plow Width
LJ-6010	2 3/4" (60 mm)	2 1/4" (57 mm)	1 1/2" (38 mm)	N/A
LJ-6010P	2 3/4" (60 mm)	2 1/4" (57 mm)	1 1/2" (38 mm)	1 1/4" (32 mm)
LJ-6109	2 1/4" (73 mm)	1 7/8" (48 mm)	2 3/4" (60 mm)	N/A
LJ-6109P0	2 1/8" (73 mm)	1 7/8" (48 mm)	2 3/4" (60 mm)	1 1/4" (32 mm)
LJ-6601	2 1/4" (57 mm)	2 1/4" (57 mm)	1 1/2" (38 mm)	N/A
LJ-6601P	2 1/4" (57 mm)	2 1/4" (57 mm)	1 1/2" (38 mm)	1 1/4" (32 mm)
LJ-6A10	2 3/4" (60 mm)	2" (51 mm)	2 1/4" (54 mm)	N/A
LJ-6A10P0	2 3/4" (60 mm)	2" (51 mm)	2 1/4" (54 mm)	1 1/4" (32 mm)
LJ-6B10	2 3/4" (60 mm)	2" (51 mm)	2 3/4" (60 mm)	N/A
LJ-6B10P0	2 3/4" (60 mm)	2" (51 mm)	2 3/4" (60 mm)	1 1/4" (32 mm)

Shoerail and Fillet:	Height	Width	Plow Width
LJ-6045	3/4" (19 mm)	2 1/2" (64 mm)	1 1/4" (32 mm)
LJ-6050	3/8" (10 mm)	1 1/4" (32 mm)	N/A

Balusters:	Top Block	Turning Length	Bottom Block	Square Size	Overall Length
LJ-5015ND-31‡	N/A	22 3/4" (575 mm)	8 3/8" (213 mm)	1 1/4" (32 mm)	31" (787 mm)
LJ-5015-34	N/A	28" (711 mm)	6" (152 mm)	1 1/4" (32 mm)	34" (864 mm)
LJ-5015-38	N/A	28" (711 mm)	10" (254 mm)	1 1/4" (32 mm)	38" (965 mm)
LJ-5015-42	N/A	28" (711 mm)	14" (356 mm)	1 1/4" (32 mm)	42" (1067 mm)
S-5015-31	N/A	22 3/4" (575 mm)	7 7/8" (193 mm)	1 1/4" (32 mm)	31" (787 mm)
S-5015-34	N/A	25 3/4" (651 mm)	7 7/8" (193 mm)	1 1/4" (32 mm)	34" (864 mm)
S-5015-36	N/A	27 3/4" (702 mm)	7 7/8" (193 mm)	1 1/4" (32 mm)	36" (914 mm)
S-5015-39	N/A	30 3/4" (778 mm)	7 7/8" (193 mm)	1 1/4" (32 mm)	39" (990 mm)
S-5015-42	N/A	33 3/4" (854 mm)	7 7/8" (193 mm)	1 1/4" (32 mm)	42" (1067 mm)
LJ-5035-34	N/A	28" (711 mm)	6" (152 mm)	1 1/4" (32 mm)	34" (864 mm)
LJ-5035-38	N/A	28" (711 mm)	10" (254 mm)	1 1/4" (32 mm)	38" (965 mm)
LJ-5035-42	N/A	28" (711 mm)	14" (356 mm)	1 1/4" (32 mm)	42" (1067 mm)
LJ-5040-34	N/A	34" (864 mm)	N/A	1 1/8" Diam. (29 mm)	34" (864 mm)
LJ-5040-38	N/A	38" (965 mm)	N/A	1 1/8" Diam. (29 mm)	38" (965 mm)
LJ-5040-42	N/A	42" (1067 mm)	N/A	1 1/8" Diam. (29 mm)	42" (1067 mm)
S-5040-31	N/A	30 3/4" (768 mm)	N/A	1 1/8" Diam. (29 mm)	31" (787 mm)
S-5040-34	N/A	33 1/4" (845 mm)	N/A	1 1/8" Diam. (29 mm)	34" (864 mm)
S-5040-36	N/A	35 1/4" (895 mm)	N/A	1 1/8" Diam. (29 mm)	36" (914 mm)
S-5040-39	N/A	38 1/4" (972 mm)	N/A	1 1/8" Diam. (29 mm)	39" (990 mm)
S-5040-42	N/A	41 1/4" (1048 mm)	N/A	1 1/8" Diam. (29 mm)	42" (1067 mm)
LJ-5067-34	7" (178 mm)	20" (508 mm)	7" (178 mm)	1 1/4" (32 mm)	34" (864 mm)
LJ-5067-38	7" (178 mm)	20" (508 mm)	11" (279 mm)	1 1/4" (32 mm)	38" (965 mm)
LJ-5067-42	7" (178 mm)	20" (508 mm)	15" (381 mm)	1 1/4" (32 mm)	42" (1067 mm)
S-5067-31	5 1/4" (133 mm)	19 1/4" (486 mm)	5 7/8" (149 mm)	1 1/4" (32 mm)	31" (787 mm)
S-5067-34	5 7/8" (149 mm)	21 1/2" (546 mm)	5 7/8" (149 mm)	1 1/4" (32 mm)	34" (864 mm)
S-5067-36	5 9/8" (136 mm)	24" (610 mm)	5 7/8" (149 mm)	1 1/4" (32 mm)	36" (914 mm)
S-5067-39	5 1/4" (133 mm)	27 1/8" (689 mm)	5 7/8" (149 mm)	1 1/4" (32 mm)	39" (990 mm)
S-5067-42	7 3/4" (194 mm)	27 3/4" (705 mm)	5 7/8" (149 mm)	1 1/4" (32 mm)	42" (1067 mm)

* Length is from the top of the bottom block to the top of the baluster
 ‡ This baluster is for kneewall stairways only. It is NOT predrilled and does NOT include the Pin E-Z.

Product Dimensions

Balusters:	Top Block	Turning Length	Bottom Block	Square Size	Overall Length
LJ-5141ND-31‡	5 1/4" (133 mm)	16 3/4" (425 mm)	9" (229 mm)	1 1/4" (32 mm)	31" (787 mm)
LJ-5141-34	7" (178 mm)	20" (508 mm)	7" (178 mm)	1 1/4" (32 mm)	34" (864 mm)
LJ-5141-38	7" (178 mm)	20" (508 mm)	11" (279 mm)	1 1/4" (32 mm)	38" (965 mm)
LJ-5141-42	7" (178 mm)	20" (508 mm)	15" (381 mm)	1 1/4" (32 mm)	42" (1067 mm)
S-5141-31	5 1/4" (133 mm)	16 3/4" (425 mm)	8 1/4" (210 mm)	1 1/4" (32 mm)	31" (787 mm)
S-5141-34	6 1/4" (159 mm)	18 3/4" (476 mm)	8 1/4" (210 mm)	1 1/4" (32 mm)	34" (864 mm)
S-5141-36	6 1/4" (159 mm)	20 3/4" (527 mm)	8 1/4" (210 mm)	1 1/4" (32 mm)	36" (914 mm)
S-5141-39	6 1/4" (159 mm)	23 3/4" (603 mm)	8 1/4" (210 mm)	1 1/4" (32 mm)	39" (990 mm)
S-5141-42	6 1/4" (159 mm)	26 3/4" (679 mm)	8 1/4" (210 mm)	1 1/4" (32 mm)	42" (1067 mm)

* Length is from the top of the bottom block to the top of the baluster
 ‡ This baluster is for kneewall stairways only. It is NOT predrilled and does NOT include the Pin E-Z.

Newel Posts:	Turning Length	Bottom Block	Square Size	Overall Length
Starting Newels				
LJ-4050	27" (686 mm)	15" (381 mm) turned bottom	2 1/4" (57 mm)	43" (1092 mm)
LJ-4060	27" (686 mm)	15" (381 mm) turned bottom	2 3/4" (70 mm)	43" (1092 mm)
Utility Newels				
LJ-4010	27" (686 mm)	15" (381 mm)	3" (76 mm)	43" (1092 mm)
LJ-4014	27" (686 mm)	22" (559 mm)	3" (76 mm)	50" (1270 mm)
Intermediate Landing Newels				
LJ-4015	27" (686 mm)	30" (762 mm)	3" (76 mm)	58" (1473 mm)
LJ-4017	27" (686 mm)	37" (940 mm)	3" (76 mm)	65" (1651 mm)
LJ-4018	27" (686 mm)	45" (1143 mm)	3" (76 mm)	73" (1854 mm)
Rake Newel				
LJ-4013PT	27" (686 mm)	16" (406 mm)	3" (76 mm)	43" (1092 mm)

† Diameter dimension

Pictured Right: LJ-6010 Handrail, LJ-4010 Newel, LJ-5015 Balusters and LJ-7030 Left Hand Volute.

Pictured Far Right: LJ-6010 Handrail, LJ-4010 Newels, LJ-5015 Balusters LJ-7030 Left Hand Volute and LJ-7035 Right Hand Volute.

Newel Posts



LJ-4010
LJ-4014
LJ-4015
LJ-4017
LJ-4018



LJ-4013PT



LJ-4050
Turned
Bottom



LJ-4060
Turned
Bottom

**Newel
Drop**



LJ-4299A

Consider iron newels for your stairway from our Iron Collection on page 68

Iron Newels

Over the Post



Classic Collection

Non-Plowed Handrails and Pin Top Balusters

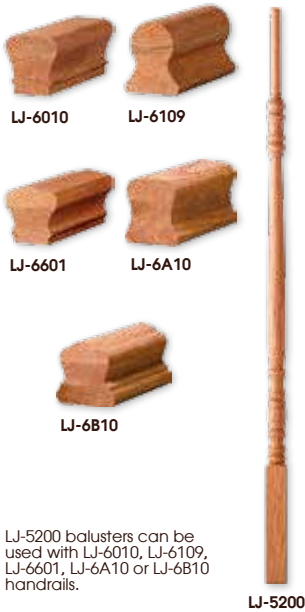

LJ-5200 balusters can be used with LJ-6010, LJ-6109, LJ-6601, LJ-6A10 or LJ-6B10 handrails.

Plowed Handrails and Square Top Balusters

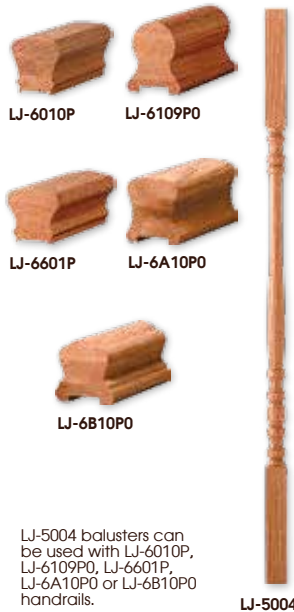

LJ-5004 balusters can be used with LJ-6010P, LJ-6109P0, LJ-6601P, LJ-6A10P0 or LJ-6B10P0 handrails.

Shoerail & Fillet



Newel Posts



Newel Drop



Consider iron newels for your stairway from our Iron Collection on page 68

Balusters on this page are pre-drilled with a 9/32" (7 mm) diameter hole at least 3" (76 mm) deep in which a pin ("Pin E-Z") is loosely inserted. Every baluster can then be installed in the traditional manner, or by using the Dowel-Fast™ screws as shown on page 85 (sold separately).

Product Dimensions

Handrails:	Height	Profile Width	Bottom Width	Plow Width	
LJ-6010	2 3/4" (60 mm)	2 1/4" (57 mm)	1 1/2" (38 mm)	N/A	
LJ-6010P	2 3/4" (60 mm)	2 1/4" (57 mm)	1 1/2" (38 mm)	1 1/4" (32 mm)	
LJ-6109	2 1/4" (73 mm)	1 7/8" (48 mm)	2 3/4" (60 mm)	N/A	
LJ-6109P0	2 1/4" (73 mm)	1 7/8" (48 mm)	2 3/4" (60 mm)	1 1/4" (32 mm)	
LJ-6601	2 1/4" (57 mm)	2 1/4" (57 mm)	1 1/2" (38 mm)	N/A	
LJ-6601P	2 1/4" (57 mm)	2 1/4" (57 mm)	1 1/2" (38 mm)	1 1/4" (32 mm)	
LJ-6A10	2 3/4" (60 mm)	2" (51 mm)	2 1/2" (54 mm)	N/A	
LJ-6A10P0	2 3/4" (60 mm)	2" (51 mm)	2 1/2" (54 mm)	1 1/4" (32 mm)	
LJ-6B10	2 3/4" (59 mm)	2" (51 mm)	2 3/4" (60 mm)	N/A	
LJ-6B10P0	2 3/4" (59 mm)	2" (51 mm)	2 3/4" (60 mm)	1 1/4" (32 mm)	
Shoerail and Fillet:	Height	Width	Plow Width		
LJ-6045	3/4" (19 mm)	2 1/2" (64 mm)	1 1/4" (32 mm)		
LJ-6050	3/4" (10 mm)	1 1/4" (32 mm)	N/A		
Balusters:	Top Block	Turning Length	Bottom Block	Square Size	Overall Length
LJ-5004ND-31‡	5 3/4" (149 mm)	16 3/4" (422 mm)	8 1/2" (216 mm)	1 1/4" (32 mm)	31" (787 mm)
LJ-5004-34	7" (178 mm)	20" (508 mm)	7" (178 mm)	1 1/4" (32 mm)	34" (864 mm)
LJ-5004-38	7" (178 mm)	20" (508 mm)	11" (279 mm)	1 1/4" (32 mm)	38" (965 mm)
LJ-5004-42	7" (178 mm)	20" (508 mm)	15" (381 mm)	1 1/4" (32 mm)	42" (1067 mm)
LJ-5200-34	N/A	27" (686 mm)	7" (178 mm)	1 1/4" (32 mm)	34" (864 mm)
LJ-5200-38	N/A	27" (686 mm)	11" (279 mm)	1 1/4" (32 mm)	38" (965 mm)
LJ-5200-42	N/A	27" (686 mm)	15" (381 mm)	1 1/4" (32 mm)	42" (1067 mm)
Newel Posts:	Turning Length	Bottom Block	Square Size	Overall Length	
LJ-3270	27" (686 mm)	15" (381 mm)	3" (76 mm)	43" (1092 mm)	
LJ-3274	27" (686 mm)	22" (559 mm)	3" (76 mm)	50" (1270 mm)	
Intermediate Landing Newels					
LJ-3275	27" (686 mm)	30" (762 mm)	3" (76 mm)	58" (1473 mm)	
LJ-3278	27" (686 mm)	45" (1143 mm)	3" (76 mm)	73" (1854 mm)	
Rake Newel					
LJ-3513PT	27 3/4" (706 mm)	20 3/4" (513 mm)	3" (76 mm)	48" (1219 mm)	

*Length is from the top of the bottom block to the top of the baluster

‡ 31" Balusters are for kneewall stairways only. They are NOT predrilled and they do NOT include the Pin E-Z.



Pictured: LJ-6010 Handrail, LJ-3270 Newel Series, LJ-5200 Balusters, LJ-7035 Right Hand Volute.

L.J. Smith's Ornamental Iron Collection offers an extensive assortment of popular styles. Our balusters are constructed from "mild" steel, making them very durable and much stronger than wrought iron versions. Each and every baluster is hand made, which means no two are exactly alike. The slight variations in the details add exceptional character to any stairway. The finishes on our iron products may vary and all components are for interior use only.

Iron Baluster Options



Solid Square



Hollow Square



Solid Round



Hollow Round

Iron Line Finishes



Satin Black (SB)



Matte Black (MB)



Matte Nickel (MN)



Low Sheen Black (LSB)



Oil Rubbed Bronze (ORB)



Oil Rubbed Copper (ORC)



Antique Bronze (ABZ)



Silver Vein (SV)

NOTE: Finishes may vary

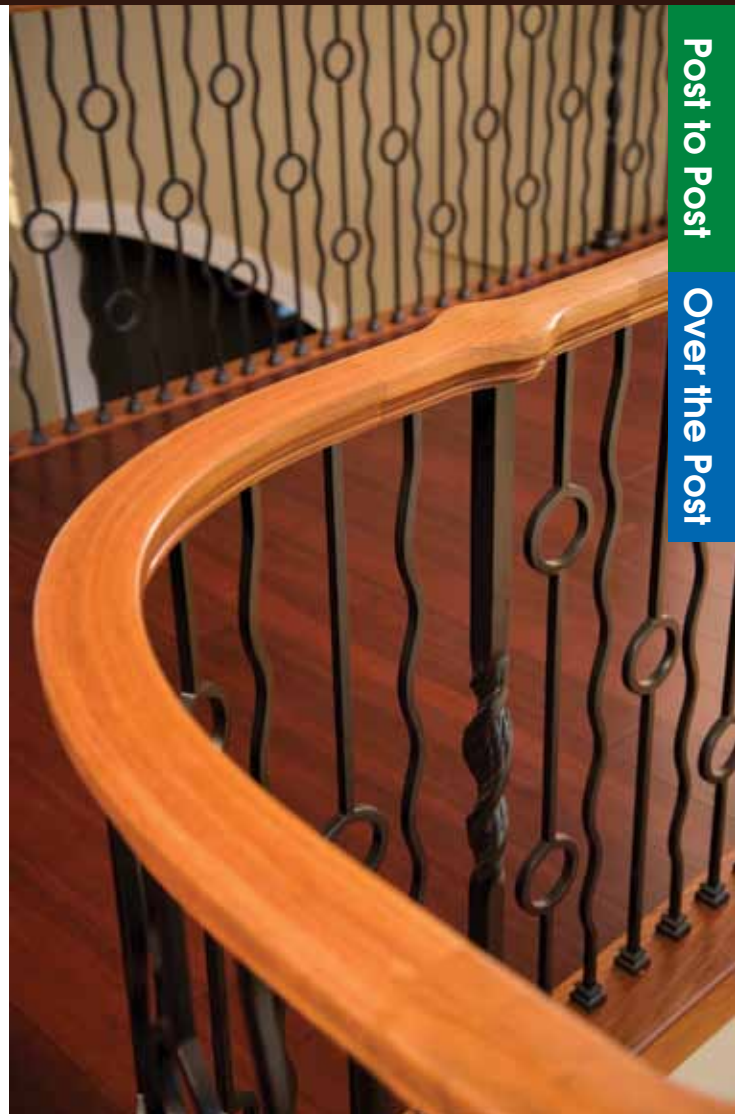

Post to Post

Over the Post



Horizon Collection - 1/2"

Over the Post Post to Post

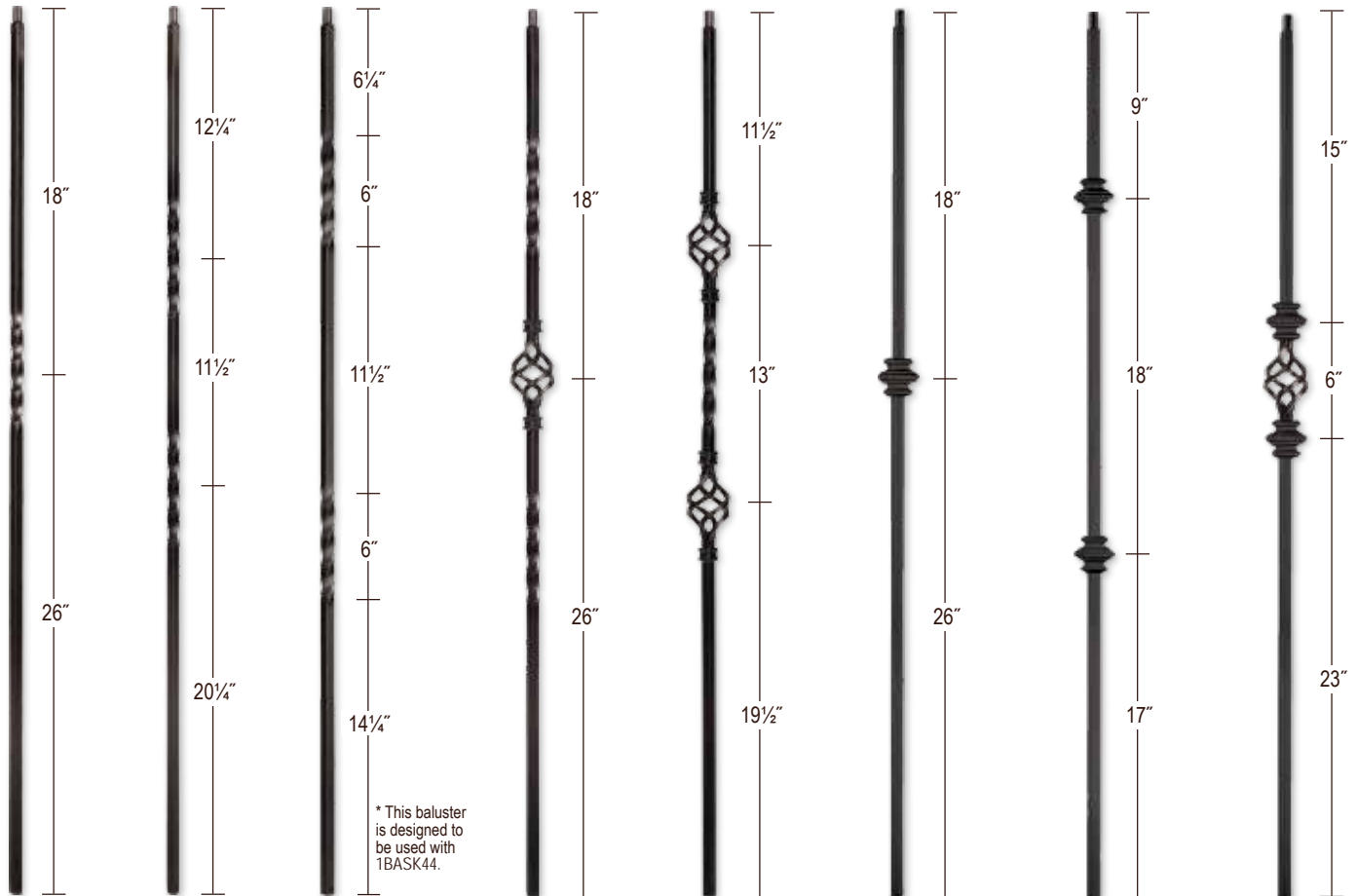

* This baluster is designed to be used with 1BASK44.

- LI-1TW44 LI-2TW44 LI-DBLTW44* LI-1BASK44 LI-2BASK44 LI-1KNUC44 LI-2KNUC44 LI-2KNUC1BASK44
- LIH-HOL1TW44 LIH-HOL2TW44 LIH-HOLDBLTW44* LIH-HOL1BASK44 LIH-HOL2BASK44 LIH-HOL1KNUC44 LIH-HOL2KNUC44

Item Number	Satin Black (SB)	Matte Black (MB)	Matte Nickel (MN)	Silver Vein (SV)	Antique Bronze (ABZ)	Oil Rubbed Copper (ORC)	Oil Rubbed Bronze (ORB)
1TW44	<input checked="" type="checkbox"/>	<input checked="" type="checkbox"/>	<input type="checkbox"/>	<input checked="" type="checkbox"/>	<input checked="" type="checkbox"/>	<input checked="" type="checkbox"/>	<input checked="" type="checkbox"/>
2TW44	<input checked="" type="checkbox"/>	<input checked="" type="checkbox"/>	<input type="checkbox"/>	<input checked="" type="checkbox"/>	<input checked="" type="checkbox"/>	<input checked="" type="checkbox"/>	<input checked="" type="checkbox"/>
DBLTW44	<input checked="" type="checkbox"/>	<input checked="" type="checkbox"/>	<input type="checkbox"/>	<input checked="" type="checkbox"/>	<input checked="" type="checkbox"/>	<input checked="" type="checkbox"/>	<input checked="" type="checkbox"/>
1BASK44	<input checked="" type="checkbox"/>	<input checked="" type="checkbox"/>	<input type="checkbox"/>	<input checked="" type="checkbox"/>	<input checked="" type="checkbox"/>	<input checked="" type="checkbox"/>	<input checked="" type="checkbox"/>
2BASK44	<input checked="" type="checkbox"/>	<input checked="" type="checkbox"/>	<input type="checkbox"/>	<input checked="" type="checkbox"/>	<input checked="" type="checkbox"/>	<input checked="" type="checkbox"/>	<input checked="" type="checkbox"/>
1KNUC44	<input checked="" type="checkbox"/>	<input checked="" type="checkbox"/>	<input type="checkbox"/>	<input checked="" type="checkbox"/>	<input checked="" type="checkbox"/>	<input checked="" type="checkbox"/>	<input checked="" type="checkbox"/>
2KNUC44	<input checked="" type="checkbox"/>	<input checked="" type="checkbox"/>	<input type="checkbox"/>	<input checked="" type="checkbox"/>	<input checked="" type="checkbox"/>	<input checked="" type="checkbox"/>	<input checked="" type="checkbox"/>
2KNUC1BASK44	<input checked="" type="checkbox"/>	<input checked="" type="checkbox"/>	<input type="checkbox"/>	<input type="checkbox"/>	<input type="checkbox"/>	<input type="checkbox"/>	<input type="checkbox"/>
LI-FSH01	<input checked="" type="checkbox"/>	<input checked="" type="checkbox"/>	<input type="checkbox"/>	<input checked="" type="checkbox"/>	<input checked="" type="checkbox"/>	<input checked="" type="checkbox"/>	<input checked="" type="checkbox"/>
LI-ALFSH01	<input checked="" type="checkbox"/>	<input checked="" type="checkbox"/>	<input type="checkbox"/>	<input checked="" type="checkbox"/>	<input checked="" type="checkbox"/>	<input checked="" type="checkbox"/>	<input checked="" type="checkbox"/>
LI-M06	<input checked="" type="checkbox"/>	<input checked="" type="checkbox"/>	<input type="checkbox"/>	<input checked="" type="checkbox"/>	<input checked="" type="checkbox"/>	<input checked="" type="checkbox"/>	<input checked="" type="checkbox"/>
LI-ALM06	<input checked="" type="checkbox"/>	<input checked="" type="checkbox"/>	<input checked="" type="checkbox"/>	<input checked="" type="checkbox"/>	<input checked="" type="checkbox"/>	<input checked="" type="checkbox"/>	<input checked="" type="checkbox"/>
LI-PSH02	<input checked="" type="checkbox"/>	<input checked="" type="checkbox"/>	<input type="checkbox"/>	<input checked="" type="checkbox"/>	<input checked="" type="checkbox"/>	<input checked="" type="checkbox"/>	<input checked="" type="checkbox"/>
LI-ALPSH02	<input checked="" type="checkbox"/>	<input checked="" type="checkbox"/>	<input type="checkbox"/>	<input checked="" type="checkbox"/>	<input checked="" type="checkbox"/>	<input checked="" type="checkbox"/>	<input checked="" type="checkbox"/>
LI-SCR04	<input checked="" type="checkbox"/>	<input checked="" type="checkbox"/>	<input type="checkbox"/>	<input checked="" type="checkbox"/>	<input checked="" type="checkbox"/>	<input checked="" type="checkbox"/>	<input checked="" type="checkbox"/>
LI-ALSCR05	<input checked="" type="checkbox"/>	<input checked="" type="checkbox"/>	<input type="checkbox"/>	<input checked="" type="checkbox"/>	<input checked="" type="checkbox"/>	<input checked="" type="checkbox"/>	<input checked="" type="checkbox"/>
LI-M020	<input checked="" type="checkbox"/>	<input checked="" type="checkbox"/>	<input type="checkbox"/>	<input type="checkbox"/>	<input type="checkbox"/>	<input type="checkbox"/>	<input type="checkbox"/>
LI-M022	<input checked="" type="checkbox"/>	<input checked="" type="checkbox"/>	<input type="checkbox"/>	<input type="checkbox"/>	<input type="checkbox"/>	<input type="checkbox"/>	<input type="checkbox"/>

See page 56 for finish samples. NOTE: Finishes may vary.

All shoes shown below and to the right are compatible with the 1/2" SQUARE balusters on these two pages.



Adjustable Knuckles are generally used with PLA44



LI-AK01
Iron



LI-ALAK02
Aluminum



LI-ALAK03
Aluminum



LI-ALAK05
Aluminum



LI-ALAK04
Aluminum

44"

KNEEWALL STAIR Balusters

The balusters shown in this box are specially designed for Kneewall stairs. The measurement from the top of the baluster to the middle of the center detail is 16" for each style.



LIH-KW1BASK44 LIH-KW2BASK44 LIH-KW1TW44 LIH-KW2TW44 LIH-KW1KNUC44 LIH-KW2KNUC44

■ LI-PLA44
□ LIH-HOLPLA44

Item Number	Satin Black (SB)	Matte Black (MB)	Matte Nickel (MN)	Silver Vein (SV)	Antique Bronze (ABZ)	Oil Rubbed Copper (ORC)	Oil Rubbed Bronze (ORB)
PLA44	■ □	■ □	□	■ □	■ □	■ □	■ □
LIH-KW1BASK44	□	□				□	
LIH-KW2BASK44	□	□				□	
LIH-KW1TW44	□	□				□	
LIH-KW2TW44	□	□				□	
LIH-KW1KNUC44	□	□				□	
LIH-KW2KNUC44	□	□				□	
LI-AK01	✓	✓	✓	✓	✓	✓	✓
LI-ALAK01	✓	✓		✓	✓	✓	✓
LI-ALAK02	✓	✓			✓	✓	✓
LI-ALAK03	✓	✓	✓	✓	✓	✓	✓
LI-ALAK04	✓	✓		✓	✓	✓	✓
LI-ALAK05	✓	✓		✓	✓	✓	✓
LI-ALRD201	✓	✓		✓	✓	✓	✓
LI-ALSQ301	✓	✓		✓	✓	✓	✓
LI-PROCOL	✓	✓		✓	✓	✓	✓
LI-PROLVL	✓						
LI-PROKNE	✓						



LI-ALSCR05
Screw Down
Aluminum



LI-M020
No Set Screw
Iron



LI-M022
No Set Screw
Iron



LI-ALRD201
No Set Screw
Aluminum



LI-ALSQ301
No Set Screw
Aluminum



LI-PROCOL
With Threaded Disc
Aluminum



LI-PROLVL
Alum/Iron



LI-PROKNE
Alum/Iron

Ribbon Collection - 1/2"

Over the Post Post to Post

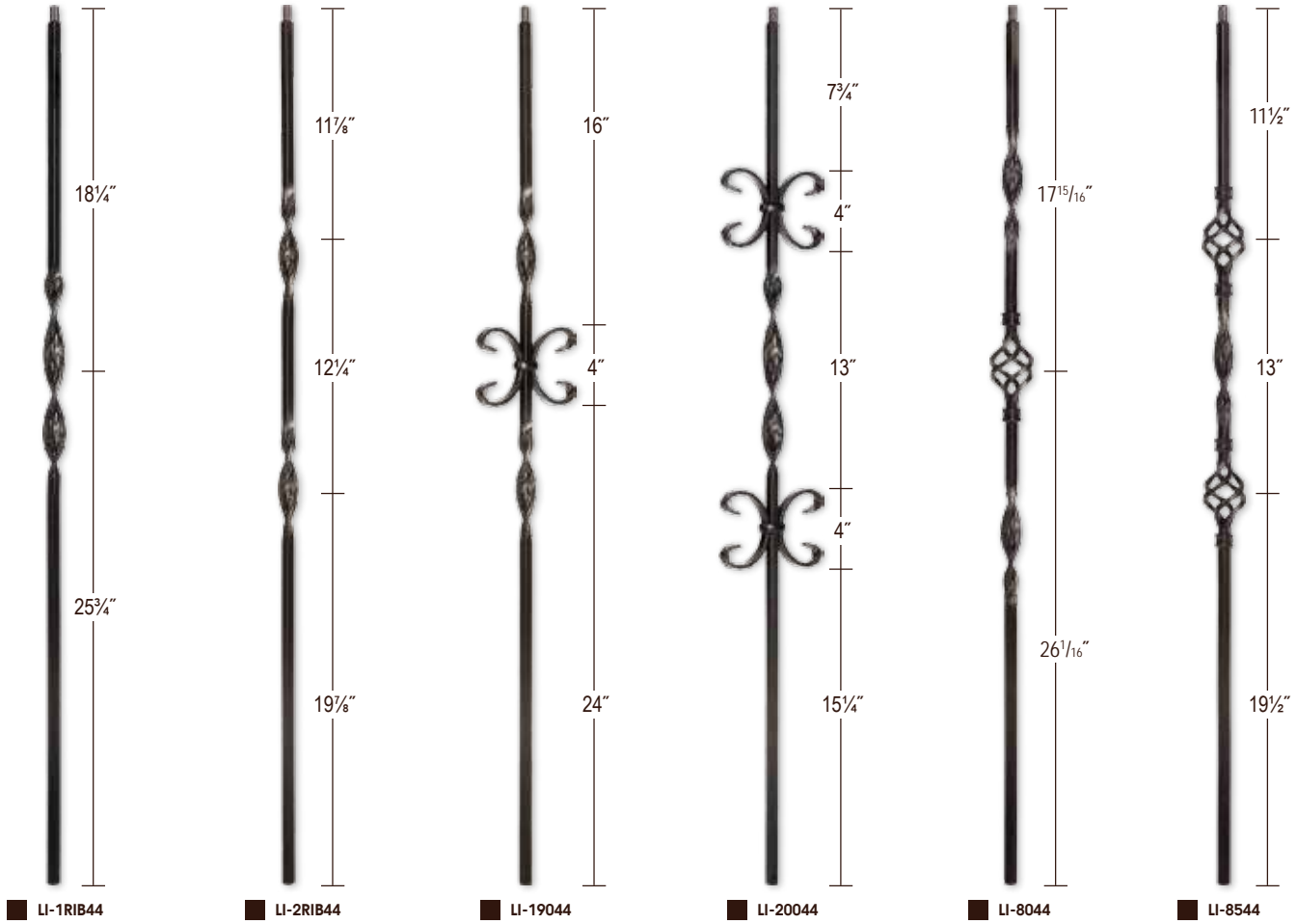

Item Number	Satin Black (SB)	Matte Black (MB)	Silver Vein (SV)	Antique Bronze (ABZ)	Oil Rubbed Copper (ORC)	Oil Rubbed Bronze (ORB)
LI-1RIB44	■	■			■	
LI-2RIB44	■	■			■	
LI-19044	■	■			■	
LI-20044	■	■			■	
LI-8044	■	■			■	
LI-8544	■	■			■	
LI-FSH01	✓	✓	✓	✓	✓	✓
LI-ALFSH01	✓	✓	✓	✓	✓	✓
LI-M06	✓	✓	✓	✓	✓	✓
LI-ALM06	✓	✓	✓	✓	✓	✓
LI-PSH02	✓	✓	✓	✓	✓	✓
LI-ALPSH02	✓	✓	✓	✓	✓	✓
LI-SCR04	✓	✓	✓	✓	✓	✓

See page 56 for finish samples. NOTE: Finishes may vary.

All shoes shown below are compatible with the 1/2" SQUARE balusters on these two pages.



LI-FSH01
No Set Screw
Iron



LI-ALFSH01
No Set Screw
Aluminum



LI-M06
With Set Screw
Iron



LI-ALM06
With Set Screw
Aluminum



LI-PSH02
With Set Screw
Iron



LI-ALPSH02
With Set Screw
Aluminum



LI-SCR04
Screw Down
Iron

Hoop Collection - 1/2"

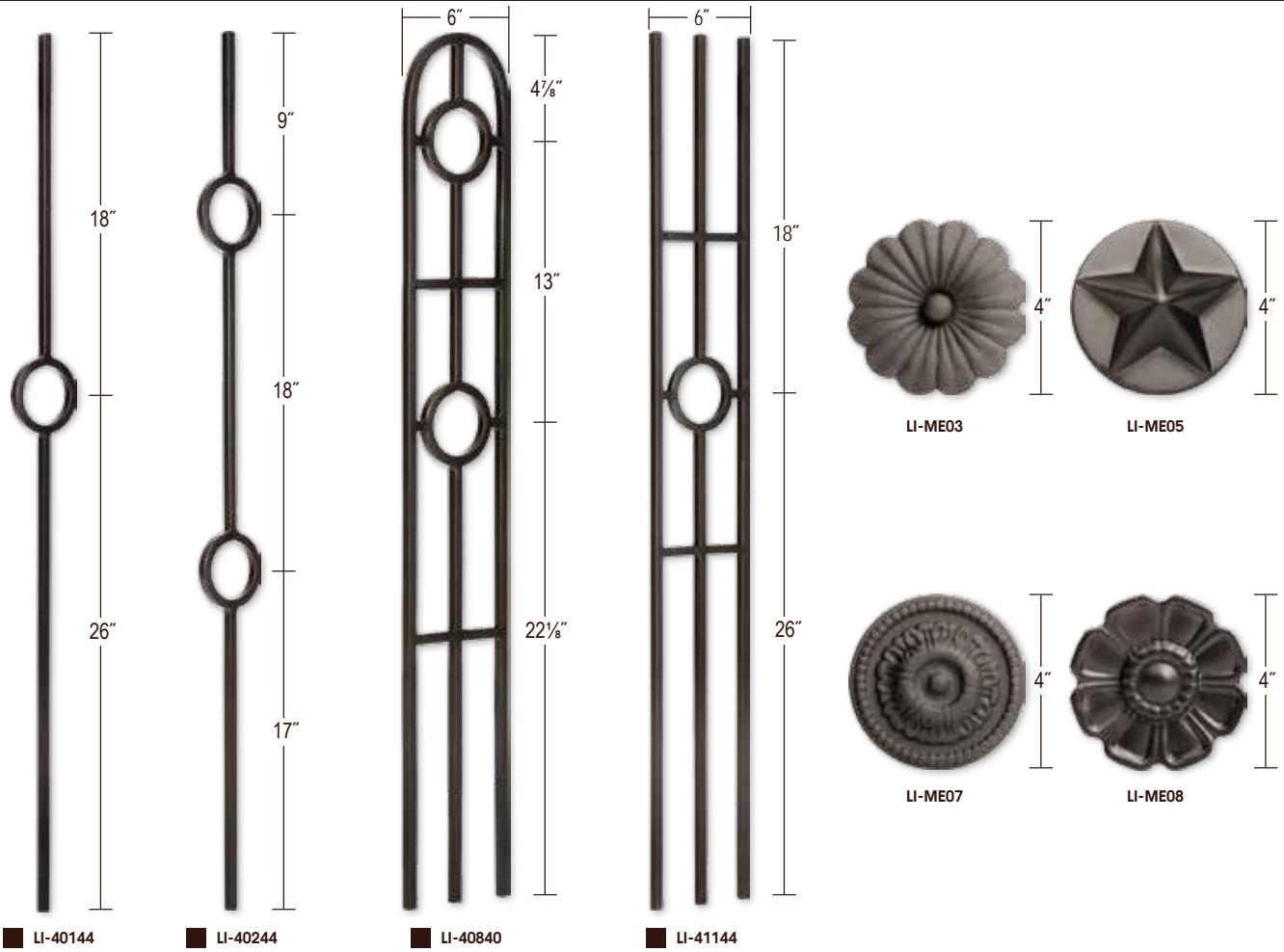

Post to Post
Over the Post

Item Number	Satin Black (SB)	Matte Black (MB)	Silver Vein (SV)	Antique Bronze (ABZ)	Oil Rubbed Copper (ORC)	Oil Rubbed Bronze (ORB)
LI-40144	■					
LI-40244	■					
LI-40840	■					
LI-41144	■					
LI-ME03	✓					
LI-ME05	✓					
LI-ME07	✓					
LI-ME08	✓					
LI-ALSCR05	✓	✓	✓	✓	✓	✓
LI-M020	✓	✓				
LI-M022	✓	✓				
LI-ALRD201	✓	✓	✓	✓	✓	✓
LI-ALSQ301	✓	✓	✓	✓	✓	✓
LI-PROCOL	✓	✓	✓	✓	✓	✓
LI-PROLVL	✓					
LI-PROKNE	✓					

See page 56 for finish samples. NOTE: Finishes may vary.

All shoes shown below are compatible with the 1/2" SQUARE balusters on these two pages
LI-ALRD201 & LI-ALSQ301 have a plastic insert and are compatible with 1/2" & 9/16" SQUARE iron balusters.



See pages 69-70 for details on IronPro

Over the Post Post to Post

KNEEWALL STAIR Balusters

The balusters shown in this box are specially designed for Kneewall stairs. The measurement from the top of the baluster to the middle of the center detail is 16" for each style.

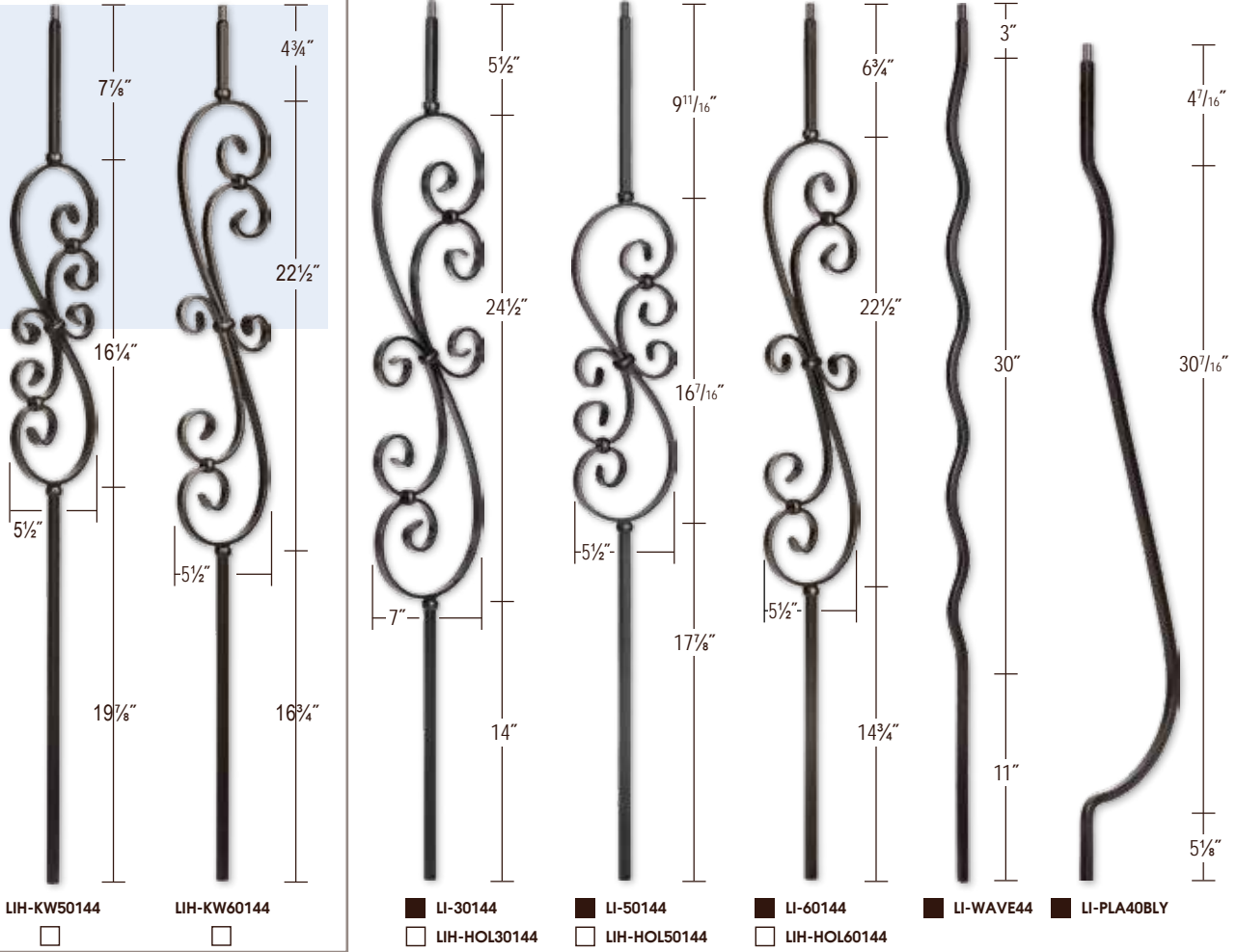

Item Number	Satin Black (SB)	Matte Black (MB)	Silver Vein (SV)	Antique Bronze (ABZ)	Oil Rubbed Copper (ORC)	Oil Rubbed Bronze (ORB)
LIH-KW50144	<input type="checkbox"/>	<input type="checkbox"/>			<input type="checkbox"/>	
LIH-KW60144	<input type="checkbox"/>	<input type="checkbox"/>			<input type="checkbox"/>	
30144	<input checked="" type="checkbox"/>	<input type="checkbox"/>	<input checked="" type="checkbox"/>	<input checked="" type="checkbox"/>	<input checked="" type="checkbox"/>	<input checked="" type="checkbox"/>
50144	<input checked="" type="checkbox"/>	<input type="checkbox"/>	<input checked="" type="checkbox"/>	<input checked="" type="checkbox"/>	<input checked="" type="checkbox"/>	<input checked="" type="checkbox"/>
60144	<input checked="" type="checkbox"/>	<input type="checkbox"/>	<input checked="" type="checkbox"/>	<input checked="" type="checkbox"/>	<input checked="" type="checkbox"/>	<input checked="" type="checkbox"/>
LI-WAVE44	<input checked="" type="checkbox"/>	<input checked="" type="checkbox"/>				
LI-PLA40BLY	<input checked="" type="checkbox"/>	<input checked="" type="checkbox"/>				
LI-FSH01	<input checked="" type="checkbox"/>	<input checked="" type="checkbox"/>	<input checked="" type="checkbox"/>	<input checked="" type="checkbox"/>	<input checked="" type="checkbox"/>	<input checked="" type="checkbox"/>
LI-ALFSH01	<input checked="" type="checkbox"/>	<input checked="" type="checkbox"/>	<input checked="" type="checkbox"/>	<input checked="" type="checkbox"/>	<input checked="" type="checkbox"/>	<input checked="" type="checkbox"/>
LI-SCR04	<input checked="" type="checkbox"/>	<input checked="" type="checkbox"/>	<input checked="" type="checkbox"/>	<input checked="" type="checkbox"/>	<input checked="" type="checkbox"/>	<input checked="" type="checkbox"/>
LI-ALSCR05	<input checked="" type="checkbox"/>	<input checked="" type="checkbox"/>	<input checked="" type="checkbox"/>	<input checked="" type="checkbox"/>	<input checked="" type="checkbox"/>	<input checked="" type="checkbox"/>
LI-M020	<input checked="" type="checkbox"/>	<input checked="" type="checkbox"/>				
LI-M022	<input checked="" type="checkbox"/>	<input checked="" type="checkbox"/>				
LI-ALRD201	<input checked="" type="checkbox"/>	<input checked="" type="checkbox"/>	<input checked="" type="checkbox"/>	<input checked="" type="checkbox"/>	<input checked="" type="checkbox"/>	<input checked="" type="checkbox"/>
LI-ALSQ301	<input checked="" type="checkbox"/>	<input checked="" type="checkbox"/>	<input checked="" type="checkbox"/>	<input checked="" type="checkbox"/>	<input checked="" type="checkbox"/>	<input checked="" type="checkbox"/>

See page 56 for finish samples. NOTE: Finishes may vary.

All shoes shown below are compatible with the 1/2" SQUARE balusters on these two pages. LI-ALRD201 & LI-ALSQ301 have a plastic insert and are compatible with 1/2" & 9/16" SQUARE iron balusters.

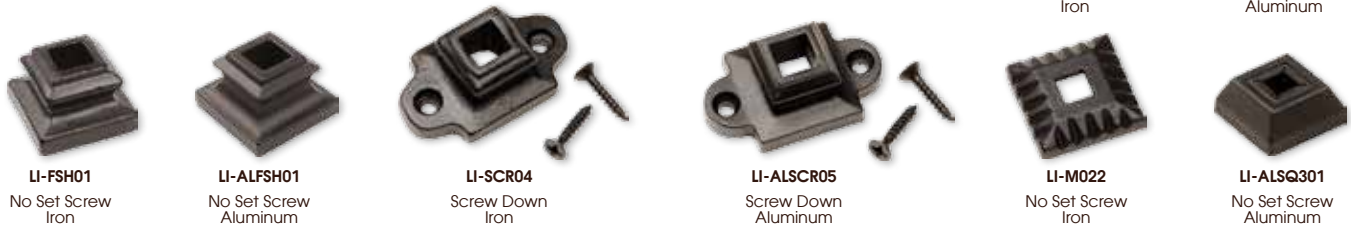

Contempo Collection - 1/2"

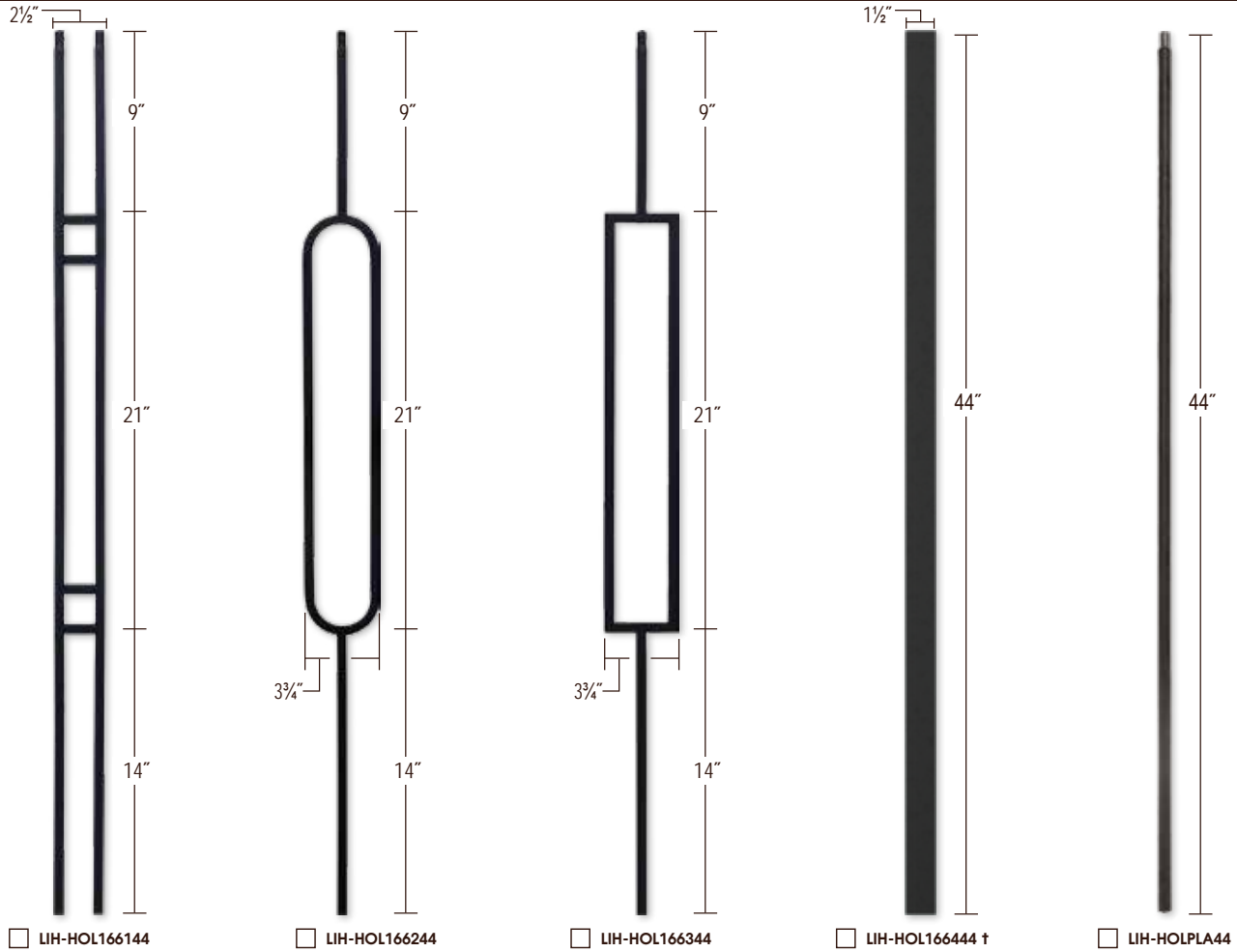

LIH-HOL166144

LIH-HOL166244

LIH-HOL166344

LIH-HOL166444 †

LIH-HOLPLA44

Post to Post

Over the Post

Item Number	Satin Black (SB)	Matte Black (MB)	Low Sheen Black (LSB)	Matte Nickel (MN)	Silver Vein (SV)	Antique Bronze (ABZ)	Oil Rubbed Copper (ORC)	Oil Rubbed Bronze (ORB)
LIH-HOL166144	<input type="checkbox"/>		<input type="checkbox"/>	<input type="checkbox"/>				
LIH-HOL166244	<input type="checkbox"/>		<input type="checkbox"/>	<input type="checkbox"/>				
LIH-HOL166344	<input type="checkbox"/>		<input type="checkbox"/>	<input type="checkbox"/>				
LIH-HOL166444	<input type="checkbox"/>		<input type="checkbox"/>	<input type="checkbox"/>			<input type="checkbox"/>	
LIH-HOLPLA44	<input type="checkbox"/>	<input type="checkbox"/>	<input type="checkbox"/>	<input type="checkbox"/>		<input type="checkbox"/>	<input type="checkbox"/>	<input type="checkbox"/>
LI-ALSQ301	✓	✓			✓	✓	✓	✓
LI-M06	✓	✓			✓	✓	✓	✓
LI-ALM06	✓	✓	✓	✓	✓	✓	✓	✓
LI-PSH02	✓	✓			✓	✓	✓	✓
LI-ALPSH02	✓	✓	✓	✓	✓	✓	✓	✓
LI-PROCOL	✓	✓			✓	✓	✓	✓
LI-PROLVL	✓							
LI-PROKNE	✓							
LI-ALSQPL1	✓		✓	✓			✓	✓
LI-ALSQPL2	✓		✓	✓			✓	✓
LI-ALRCPL1	✓		✓	✓			✓	
LI-ALRCPL2	✓		✓	✓			✓	

See page 56 for finish samples. NOTE: Finishes may vary.

All shoes shown below are compatible with the 1/2" SQUARE balusters on these two pages
 † LI-ALRCPL1 & LI-ALRCPL2 are compatible with LIH-HOL166444 iron balusters.

‡ Accommodates stairs up to 37° ascent.



See pages 69-70 for details on IronPro

Pummel - 9/16"

Feather - 9/16"

Over the Post Post to Post

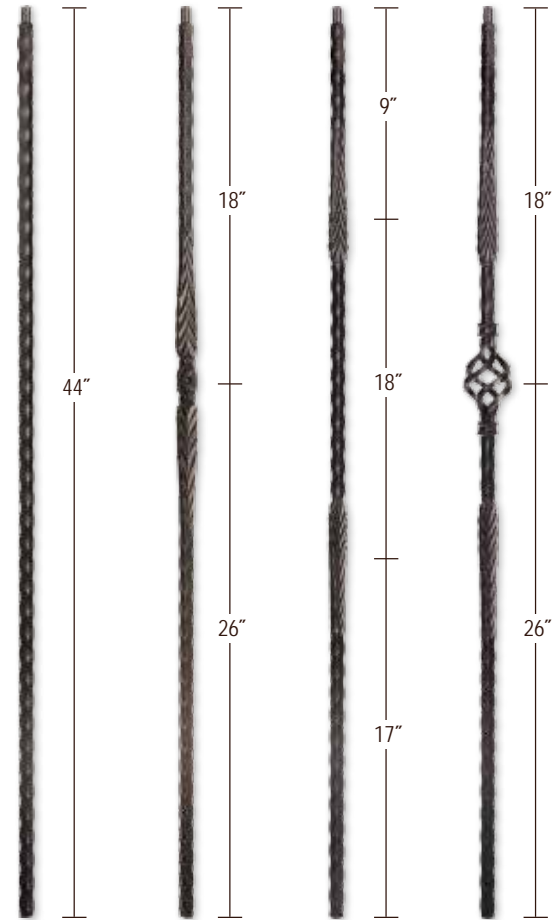
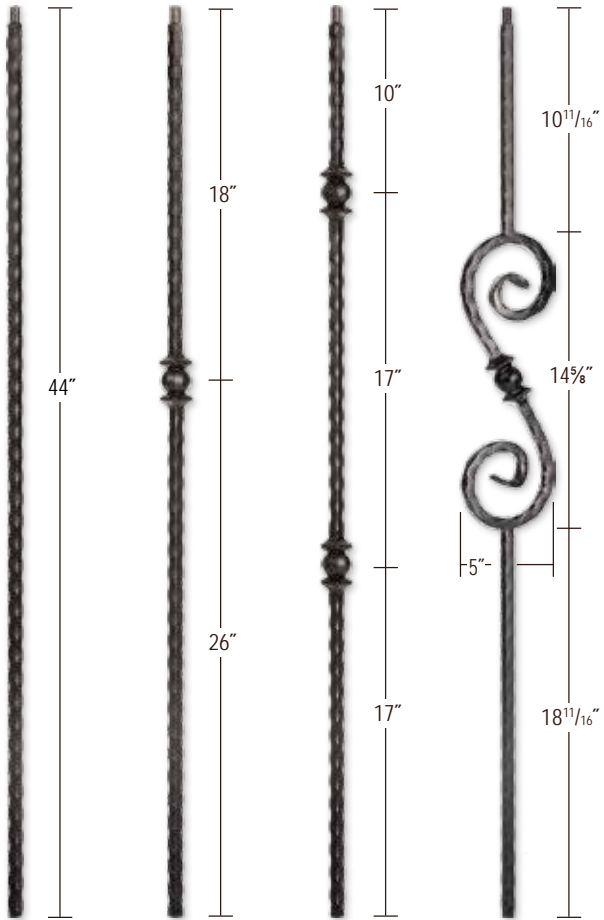

LI-9044 Hammered Edge
 LI-30544 Hammered Edge
 LI-30844 Hammered Edge
 LI-31044 Hammered Edge
 LI-9044 Hammered Edge
 LI-10044 Hammered Edge
 LI-11044 Hammered Edge
 LI-13044 Hammered Edge

Item Number	Satin Black (SB)	Matte Black (MB)	Silver Vein (SV)	Antique Bronze (ABZ)	Oil Rubbed Copper (ORC)	Oil Rubbed Bronze (ORB)
LI-9044	■	■	■	■	■	■
LI-30544	■	■	■	■	■	■
LI-30844	■	■	■	■	■	■
LI-31044	■	■	■	■	■	■
LI-10044	■	■			■	■
LI-11044	■	■			■	■
LI-13044	■	■				■
LI-H03	✓	✓	✓	✓	✓	✓
LI-H04	✓	✓	✓	✓	✓	✓
LI-H05P	✓	✓	✓	✓	✓	✓
LI-ALH05P	✓	✓	✓	✓	✓	✓

See page 56 for finish samples. NOTE: Finishes may vary.

Shoes shown below are compatible with the 9/16" SQUARE balusters shown on these two pages.



Honeycomb Collection - 9/16"



L.J. Smith
stair systems



LI-9044
Hammered Edge



LI-13144
Hammered Edge



LI-13244
Hammered Edge



LI-33044
Hammered Edge

Post to Post

Over the Post

Item Number	Satin Black (SB)	Matte Black (MB)	Silver Vein (SV)	Antique Bronze (ABZ)	Oil Rubbed Copper (ORC)	Oil Rubbed Bronze (ORB)
LI-9044	■	■	■	■	■	■
LI-13144	■	■			■	■
LI-13244	■	■			■	■
LI-33044	■	■			■	■
LI-H06	✓	✓	✓	✓	✓	✓
LI-ALH06	✓	✓	✓	✓	✓	✓
LI-ALRD201	✓	✓	✓	✓	✓	✓
LI-ALSQ301	✓	✓	✓	✓	✓	✓

See page 56 for finish samples. NOTE: Finishes may vary.

Shoes shown below are compatible with the 9/16" SQUARE balusters shown on these two pages.
LI-ALRD201 & LI-ALSQ301 have a plastic insert and are compatible with 1/2" & 9/16" SQUARE iron balusters.



LI-H06
With Set Screw
Iron



LI-ALH06
With Set Screw
Aluminum



LI-ALRD201
No Set Screw
Aluminum



LI-ALSQ301
No Set Screw
Aluminum

Camelot Collection - 9/16"



Over the Post Post to Post

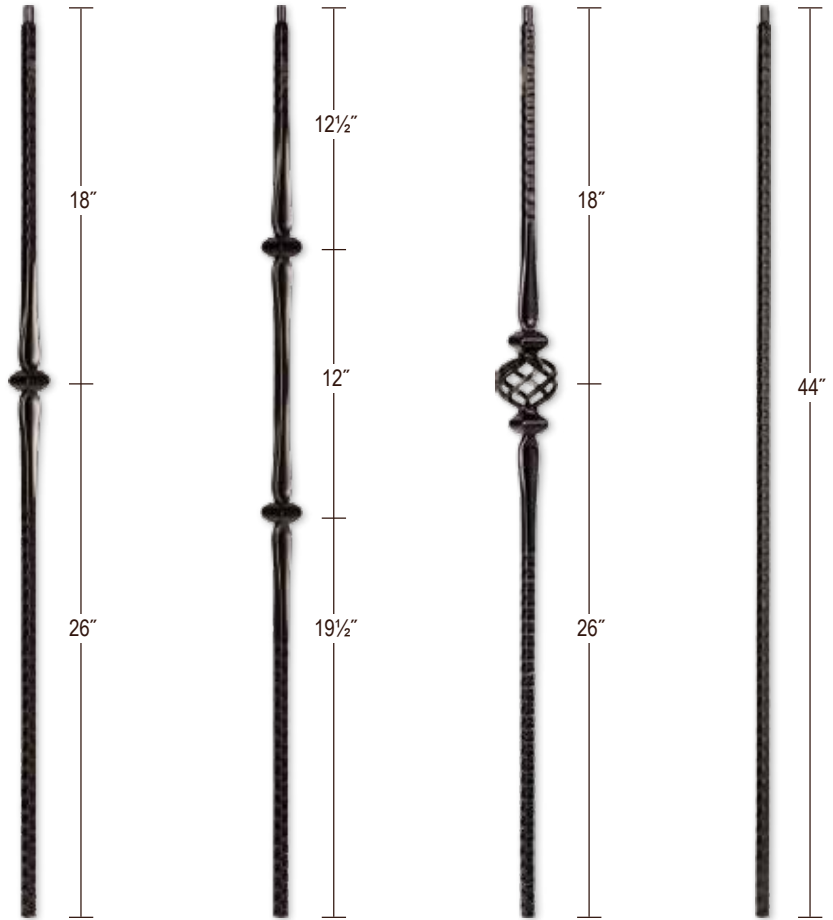

Pictured: LIH-HOL15044 and LIH-HOL16044 Iron Balusters, LJ-4091 Box Newel, LJ-6010 Handrail.

- LI-14044 LI-15044 LI-16044 LI-14344
- LIH-HOL14044 LIH-HOL15044 LIH-HOL16044 LIH-HOL14344
- Hammered Face* *Hammered Face* *Hammered Face* *Hammered Face*

Item Number	Satin Black (SB)	Matte Black (MB)	Silver Vein (SV)	Antique Bronze (ABZ)	Oil Rubbed Copper (ORC)	Oil Rubbed Bronze (ORB)
14044	<input checked="" type="checkbox"/> <input type="checkbox"/>	<input checked="" type="checkbox"/> <input type="checkbox"/>	<input checked="" type="checkbox"/> <input type="checkbox"/>	<input checked="" type="checkbox"/> <input type="checkbox"/>	<input checked="" type="checkbox"/> <input type="checkbox"/>	<input checked="" type="checkbox"/> <input type="checkbox"/>
15044	<input checked="" type="checkbox"/> <input type="checkbox"/>	<input checked="" type="checkbox"/> <input type="checkbox"/>	<input checked="" type="checkbox"/> <input type="checkbox"/>	<input checked="" type="checkbox"/> <input type="checkbox"/>	<input checked="" type="checkbox"/> <input type="checkbox"/>	<input checked="" type="checkbox"/> <input type="checkbox"/>
16044	<input checked="" type="checkbox"/> <input type="checkbox"/>	<input checked="" type="checkbox"/> <input type="checkbox"/>	<input checked="" type="checkbox"/> <input type="checkbox"/>	<input checked="" type="checkbox"/> <input type="checkbox"/>	<input checked="" type="checkbox"/> <input type="checkbox"/>	<input checked="" type="checkbox"/> <input type="checkbox"/>
14344	<input checked="" type="checkbox"/> <input type="checkbox"/>	<input checked="" type="checkbox"/> <input type="checkbox"/>	<input checked="" type="checkbox"/> <input type="checkbox"/>	<input checked="" type="checkbox"/> <input type="checkbox"/>	<input checked="" type="checkbox"/> <input type="checkbox"/>	<input checked="" type="checkbox"/> <input type="checkbox"/>
LI-H03	<input checked="" type="checkbox"/>	<input checked="" type="checkbox"/>	<input checked="" type="checkbox"/>	<input checked="" type="checkbox"/>	<input checked="" type="checkbox"/>	<input checked="" type="checkbox"/>
LI-H04	<input checked="" type="checkbox"/>	<input checked="" type="checkbox"/>	<input checked="" type="checkbox"/>	<input checked="" type="checkbox"/>	<input checked="" type="checkbox"/>	<input checked="" type="checkbox"/>
LI-H05P	<input checked="" type="checkbox"/>	<input checked="" type="checkbox"/>	<input checked="" type="checkbox"/>	<input checked="" type="checkbox"/>	<input checked="" type="checkbox"/>	<input checked="" type="checkbox"/>
LI-ALH05P	<input checked="" type="checkbox"/>	<input checked="" type="checkbox"/>	<input checked="" type="checkbox"/>	<input checked="" type="checkbox"/>	<input checked="" type="checkbox"/>	<input checked="" type="checkbox"/>
LI-H06	<input checked="" type="checkbox"/>	<input checked="" type="checkbox"/>	<input checked="" type="checkbox"/>	<input checked="" type="checkbox"/>	<input checked="" type="checkbox"/>	<input checked="" type="checkbox"/>
LI-ALH06	<input checked="" type="checkbox"/>	<input checked="" type="checkbox"/>	<input checked="" type="checkbox"/>	<input checked="" type="checkbox"/>	<input checked="" type="checkbox"/>	<input checked="" type="checkbox"/>
LI-ALRD201	<input checked="" type="checkbox"/>	<input checked="" type="checkbox"/>	<input checked="" type="checkbox"/>	<input checked="" type="checkbox"/>	<input checked="" type="checkbox"/>	<input checked="" type="checkbox"/>
LI-ALSQ301	<input checked="" type="checkbox"/>	<input checked="" type="checkbox"/>	<input checked="" type="checkbox"/>	<input checked="" type="checkbox"/>	<input checked="" type="checkbox"/>	<input checked="" type="checkbox"/>

See page 56 for finish samples. NOTE: Finishes may vary.

Shoes shown below are compatible with the 9/16" SQUARE balusters shown on this page. LI-ALRD201 & LI-ALSQ301 have a plastic insert and are compatible with 1/2" & 9/16" SQUARE iron balusters.



Espresso - 5/8"

Orb - 1/2"

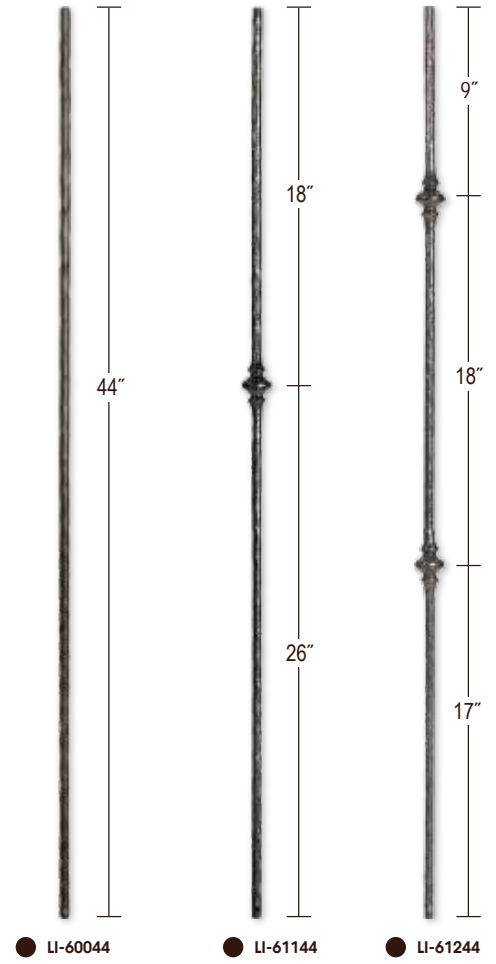
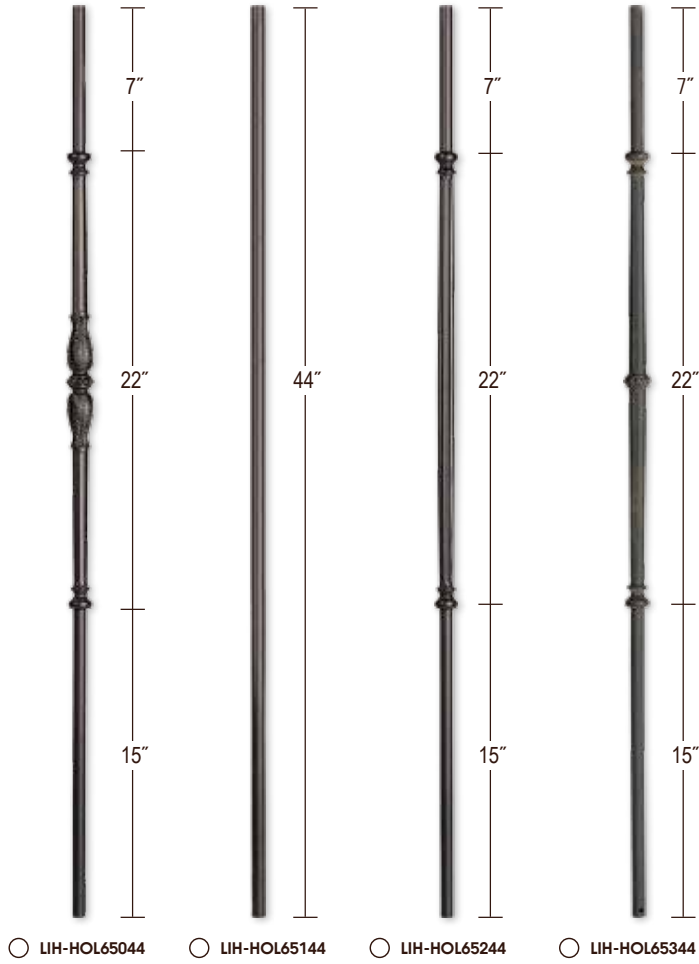

Post to Post

Over the Post

Item Number	Satin Black (SB)	Matte Black (MB)	Oil Rubbed Copper (ORC)	Oil Rubbed Bronze (ORB)
LIH-HOL65044	<input type="radio"/>	<input type="radio"/>	<input type="radio"/>	<input type="radio"/>
LIH-HOL65144	<input type="radio"/>	<input type="radio"/>	<input type="radio"/>	<input type="radio"/>
LIH-HOL65244	<input type="radio"/>	<input type="radio"/>	<input type="radio"/>	<input type="radio"/>
LIH-HOL65344	<input type="radio"/>	<input type="radio"/>	<input type="radio"/>	<input type="radio"/>
LI-R010	<input checked="" type="checkbox"/>	<input checked="" type="checkbox"/>	<input checked="" type="checkbox"/>	<input checked="" type="checkbox"/>

See page 56 for finish samples. NOTE: Finishes may vary.

Item Number	Satin Black (SB)	Matte Black (MB)	Oil Rubbed Copper (ORC)	Oil Rubbed Bronze (ORB)
LI-60044	<input checked="" type="checkbox"/>	<input checked="" type="checkbox"/>	<input checked="" type="checkbox"/>	<input checked="" type="checkbox"/>
LI-61144	<input checked="" type="checkbox"/>	<input checked="" type="checkbox"/>	<input checked="" type="checkbox"/>	<input checked="" type="checkbox"/>
LI-61244	<input checked="" type="checkbox"/>	<input checked="" type="checkbox"/>	<input checked="" type="checkbox"/>	<input checked="" type="checkbox"/>
LI-R08F	<input checked="" type="checkbox"/>	<input checked="" type="checkbox"/>	<input checked="" type="checkbox"/>	<input checked="" type="checkbox"/>
LI-R09P	<input checked="" type="checkbox"/>	<input checked="" type="checkbox"/>	<input checked="" type="checkbox"/>	<input checked="" type="checkbox"/>

NOTE: Finishes may vary.

Shoe shown below is compatible with the 5/8" ROUND balusters above.



LI-R010
No Set Screw
Iron



LI-R08F
No Set Screw
Iron



LI-R09P
With Set Screw
Iron

Shoes shown below are compatible with the 1/2" ROUND balusters above.

Mega Collection - 3/4"

Over the Post Post to Post

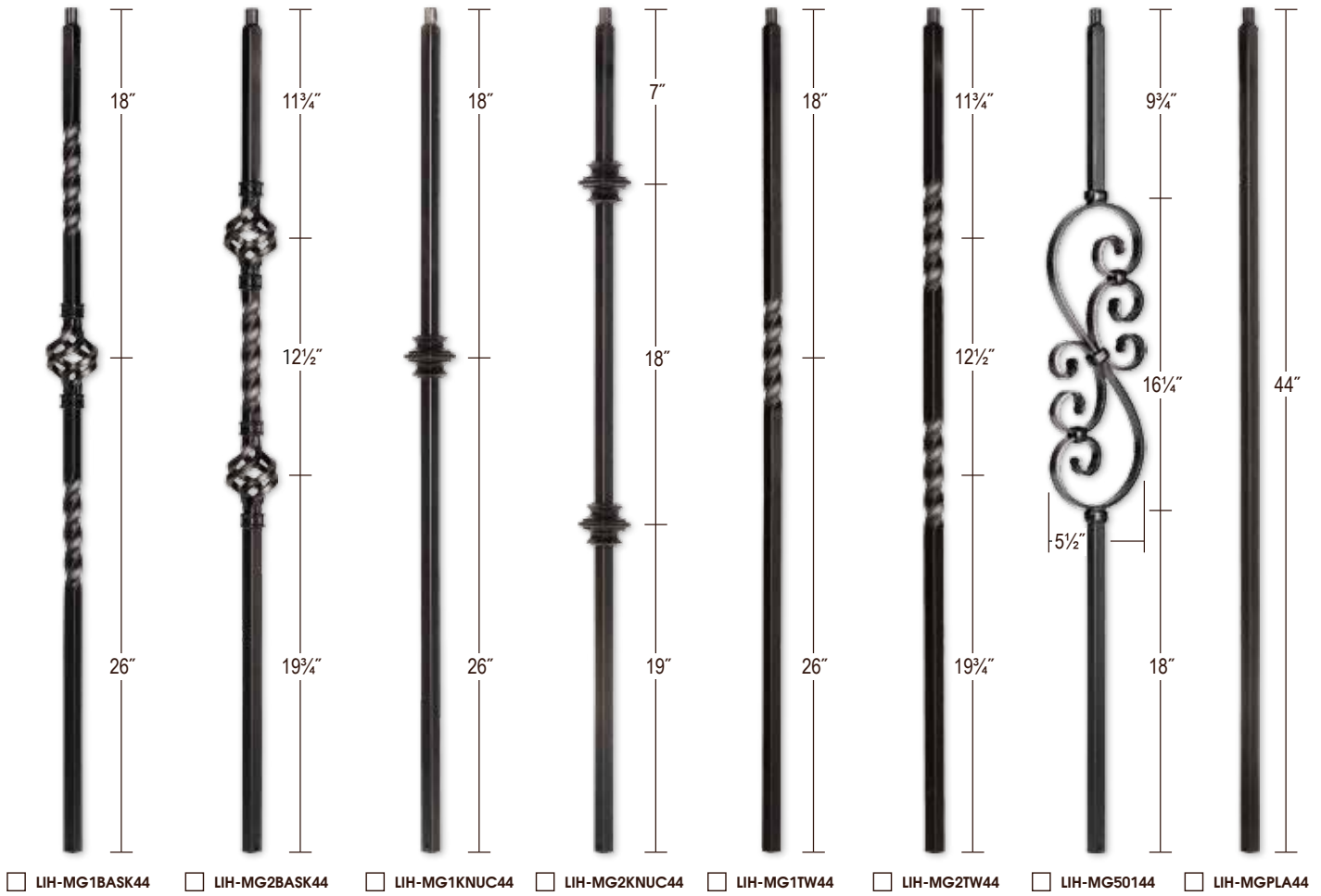

Item Number	Satin Black (SB)	Matte Black (MB)	Antique Bronze (ABZ)	Oil Rubbed Copper (ORC)
LIH-MG1BASK44	<input type="checkbox"/>	<input type="checkbox"/>	<input type="checkbox"/>	<input type="checkbox"/>
LIH-MG2BASK44	<input type="checkbox"/>	<input type="checkbox"/>	<input type="checkbox"/>	<input type="checkbox"/>
LIH-MG1KNUC44	<input type="checkbox"/>	<input type="checkbox"/>	<input type="checkbox"/>	<input type="checkbox"/>
LIH-MG2KNUC44	<input type="checkbox"/>	<input type="checkbox"/>	<input type="checkbox"/>	<input type="checkbox"/>
LIH-MG1TW44	<input type="checkbox"/>	<input type="checkbox"/>	<input type="checkbox"/>	<input type="checkbox"/>
LIH-MG2TW44	<input type="checkbox"/>	<input type="checkbox"/>	<input type="checkbox"/>	<input type="checkbox"/>
LIH-MG50144	<input type="checkbox"/>	<input type="checkbox"/>	<input type="checkbox"/>	<input type="checkbox"/>
LIH-MGPLA44	<input type="checkbox"/>	<input type="checkbox"/>	<input type="checkbox"/>	<input type="checkbox"/>
LI-ALMGFSH08	✓	✓	✓	✓
LI-ALMGM08	✓	✓	✓	✓
LI-ALMGPSH08	✓	✓	✓	✓

See page 56 for finish samples. NOTE: Finishes may vary.

Shoes shown below are compatible with the 3/4" SQUARE balusters shown on this page.



LI-ALMGFSH08
No Set Screw
Aluminum



LI-ALMGM08
With Set Screw
Aluminum



LI-ALMGPSH08
With Set Screw
Aluminum

Iron Newels - 1 3/16"

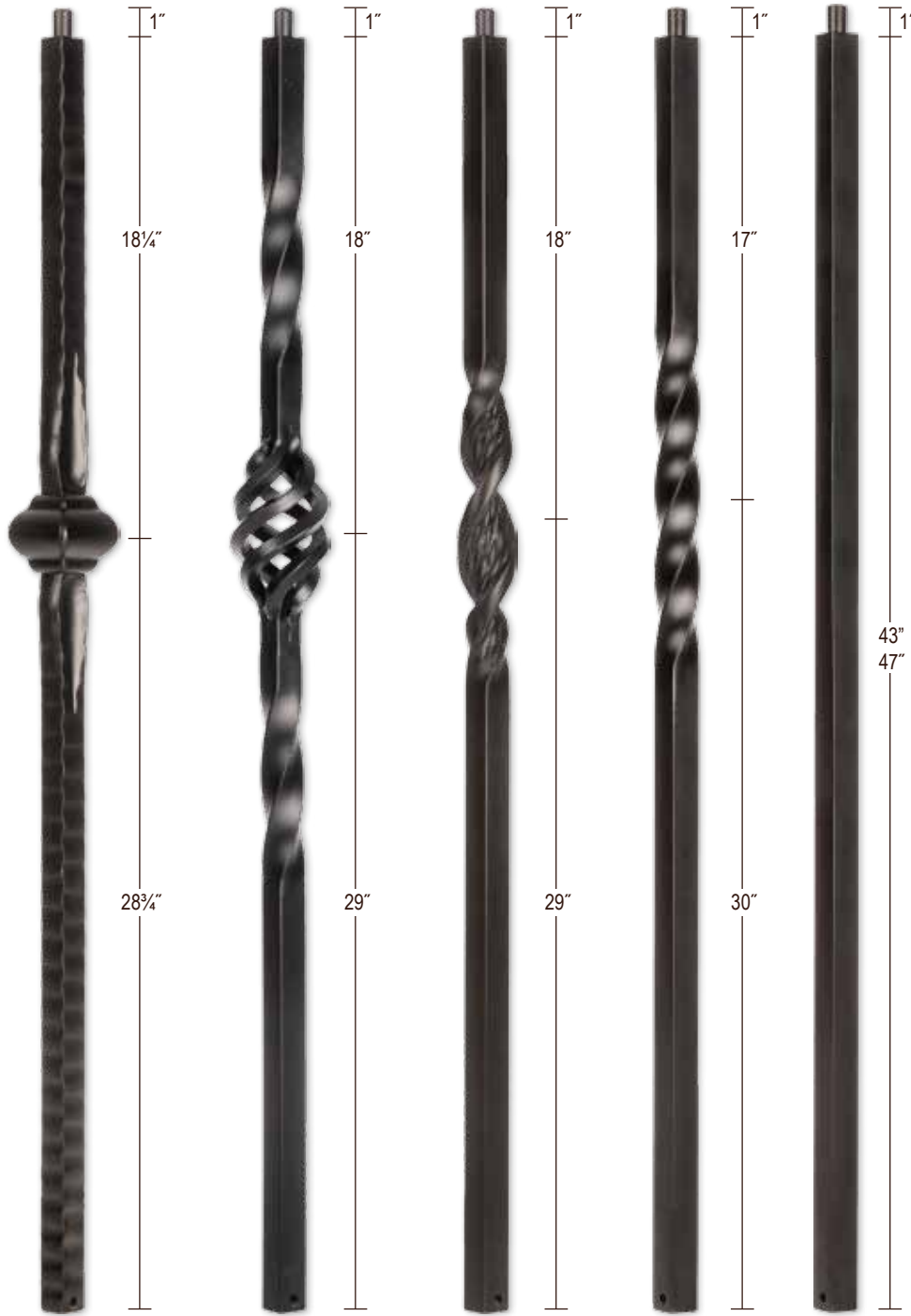

LI-NWL14048

LI-NWLBASK48

LI-NWLRIB48

LI-NWLTW48

LIH-NWLPLA44 (44")

LIH-NWLPLA48 (48")



LI-NWLFSH
Newel Collar and
Mounting Kit

Item Number	Satin Black (SB)	Matte Black (MB)	Low Sheen Black (LSB)	Silver Vein (SV)	Antique Bronze (ABZ)	Oil Rubbed Copper (ORC)	Oil Rubbed Bronze (ORB)
LI-NWL14048	■	■		■	■	■	■
LI-NWLBASK48	■	■		■	■	■	■
LI-NWLRIB48	■	■		■	■	■	■
LI-NWLTW48	■	■		■	■	■	■
LIH-NWLPLA44	□						
LIH-NWLPLA48			□				
LI-NWLFSH	✓	✓		✓	✓	✓	✓

See page 56 for finish samples. NOTE: Finishes may vary.

Over the Post

Easily Replace Wood Balusters with

IronPro™

Pat. 8,356,803

With the IronPro accessories, you can enjoy a beautiful iron balustrade and it installs in 1/3 of the time of a typical installation. IronPro is screwed

to the handrail and treads or kneewall utilizing high quality, self-drilling screws or bolts. It's ideal for remodeling too. The installation process is fast & simple with...

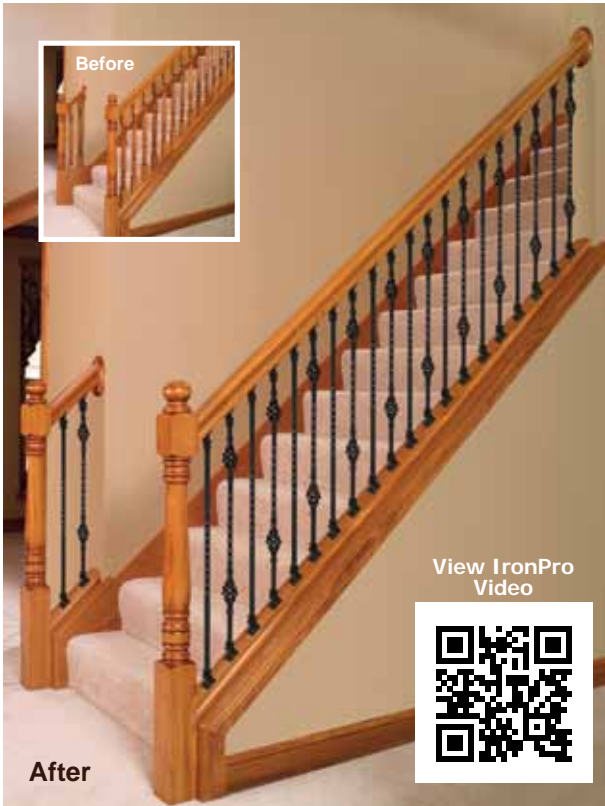
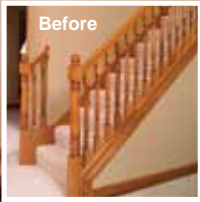

View IronPro Video

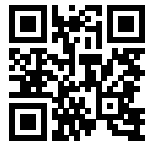

IronPro™ features:

✓ Full Flexibility

- Adjusts to up to 45° angle of ascent
- Open Tread and Kneewall Stairways

✓ Unsurpassed Durability

- Balusters are screwed into place

✓ DIY Simple Installation

- No holes to drill for most applications
- Doesn't require high-skilled labor

✓ Elegant Look

- Unique and sophisticated attachment hardware

IronPro™

1

Cut through the center of each wood baluster with a reciprocating saw, jig saw or sawzall. Remove the wood baluster sections being sure to remove any glue, debris and nails. (For stairway remodel only)



2

At the baluster locations, attach ball adaptor and round or rectangular socket to handrail and threaded disc to tread (or hanger bolt to kneewall).



3

Measure the space between the ball adaptor and threaded disc (or ball adaptor and top of hanger bolt for kneewall). Transfer this measurement to the iron baluster from the pin shoulder down the baluster. Trim each iron baluster from the bottom.



4

Pivot the ball adaptor to the side and insert iron baluster pin top. Slide the base collar (or threaded ball adaptor for kneewall) onto the baluster bottom.



Pivot Baluster

5

Align baluster and collar over threaded disc (for kneewall align baluster and threaded ball adaptor over hanger bolt). Turn baluster to secure. Tighten set screws.



Over the Post
Post to Post

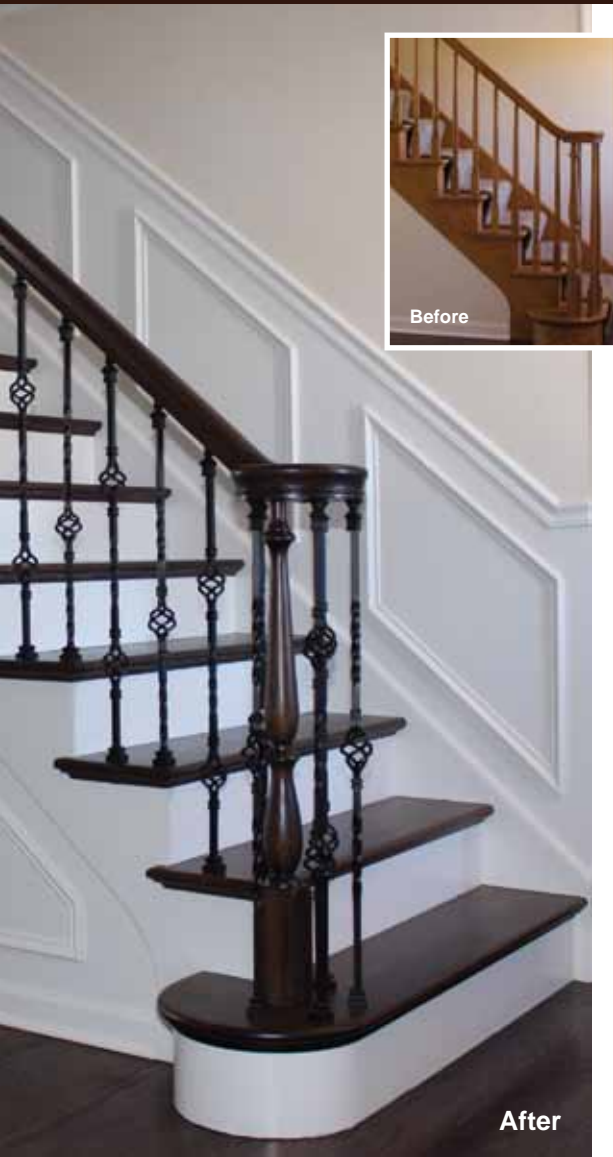

After

How to Select IronPro™ Components . . .

Open Tread Stairway

Select one *IronPro*™ Level Kit (LI-PROLVL) for each baluster you plan to install. This kit includes the items below.



Kneewall Stairway

Select one *IronPro*™ Kneewall Kit (LI-PROKNE) for each baluster you plan to install. This kit includes the items below.



Level Sections (if applicable)

Select one *IronPro*™ Level Kit for each baluster you plan to install on level sections. This is the same packet as is used for an Open Tread Stairway (above). A Kneewall Kit can be used on level sections, if preferred.

Optional Products Available . . . Used when replacing wood balusters with IronPro™

Universal Cover Plate

Select one metal Universal Cover Plate (LI-PROPLT1) for each 1¼" or 1¾" wood baluster replacement on open treads or level sections when using the Base Collar & Threaded Disc, or on a kneewall when using the Round Socket.



Rectangular Socket Cover Plate

Select one metal Rectangular Socket Cover Plate (LI-PROPLT2) for each 1¼" or 1¾" wood baluster replacement on a kneewall when using the rectangular socket.



Fillet - Use when the spacing of the balusters change in the handrail or shoerail.

LJ-6000F Fillet for 1¼" plowed handrail and/or shoerail...

LJ-6007 Fillet for 1¾" plowed handrail and/or shoerail...

Fillet is also used under non-plowed rail when the spacing of the balusters will change.

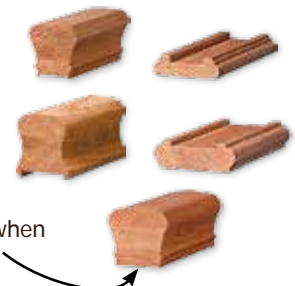

Finished Look:

Open Tread Top Connection



Kneewall Stair Top Connection



Open Tread Bottom Connection



Kneewall Stair Bottom Connection

Epoxy Adhesive Kits

We offer the following Contractor (LI-3701, LI-3702 & LI-3703) and Job-Lot (LI-3704, LI-3705 & LI-3706) Epoxy Adhesive kits for installing our Iron Balustrades.



LI-3701

Contractor Epoxy Adhesive 28 oz. (Open work time is 18 minutes. Fills approximately 122 holes depending on hole size. Includes mixing nozzle)



LI-3702
Contractor
Injector Tool



LI-3703
Contractor Epoxy
Adhesive Mixing Nozzle



LI-3704

Job-Lot Kit includes Built-in Dispensing System, 5 oz. Adhesive Cartridge and nozzle. (Open work time is 6 minutes. Fills approximately 35 holes depending on hole size.)



LI-3706
Extra Nozzle for
LI-3704 & LI-3705



LI-3705

Job-Lot Kit includes 5 oz. Adhesive Cartridge and nozzle for use in standard caulking guns. (Open work time is 6 minutes. Fills approximately 35 holes depending on hole size.)

Non-Sag Adhesives

As an alternative to our epoxy products, these adhesives offer excellent adhesion to virtually any material and perform exceedingly well as a substitute for traditional adhesives.



6100E-10AD
Non-Sag Adhesive

This non-sag adhesive is a flexible and highly versatile rubber-based compound that exhibits exceptional adhesive contact and sealant qualities. It is perfect for vertical or overhead use such as drilled holes on the underside of handrail for iron baluster installation. The tack time is approximately 4 minutes with a full cure time of 24-72 hours, depending upon amount used, temperature and humidity. Use with a standard caulk gun cartridge. Fills approximately 110 holes depending on hole size. 10.2 Oz Clear Adhesive. Dries clear.



EGEXTREME-10AD
Extreme Environmentally Friendly Adhesive

This adhesive is a high performance polyether moisture cure technology that is 100% solids, solvent free and less than 2% VOC. Extreme is odor-free making it very safe to use indoors or in confined spaces. It is engineered for strong adhesion to virtually any substrate and suitable for vertical or overhead applications making it perfect for use in drilled holes on the underside of handrail for iron baluster installation. The tack time is approximately 35 minutes with a full cure time of 3 to 7 days depending upon amount used, temperature and humidity. Use with a standard caulk gun cartridge. Fills approximately 110 holes depending on hole size. 10.1 Oz White Adhesive. Dries white.



Iron Finish Touch-up Pens

These pens are an easy and effective way to touch up a marred finish in the event that an iron baluster, newel or accessory gets chipped. Each sold separately. (Two pens are required for some finishes)

- LI-PEN-ABZ** Antique Bronze *
- LI-PEN-LSB** Low Sheen Black
- LI-PEN-MB** Matte Black
- LI-PEN-MN** Matte Nickel
- LI-PEN-ORB** Oil Rubbed Bronze *
- LI-PEN-ORC** Oil Rubbed Copper *
- LI-PEN-SB** Satin Black
- LI-PEN-SV** Silver Vein *

* To more closely match the powder coat on our iron stair parts with this finish, a Satin Black pen will also be needed.



L.J. Smith offers two types of handrail fittings in all of the handrail profiles shown near the bottom of this page. Our “Traditional” fittings utilize rail bolts for installation. L.J. Smith also offers an exclusive, patented line of fittings called “Conect-A-Kit®.” These unique fittings provide tremendous flexibility in the number of installation applications obtainable with each fitting. Aside from their common applications, seven of these fittings, used in combination, will make up 26 different Landing Fitting Assemblies (gooseneck fittings). Below are illustrations of how Conect-A-Kit® fittings are used for Common Stairway Applications, and how they are used to build Landing Fitting Assemblies (goosenecks).

What’s Inside...

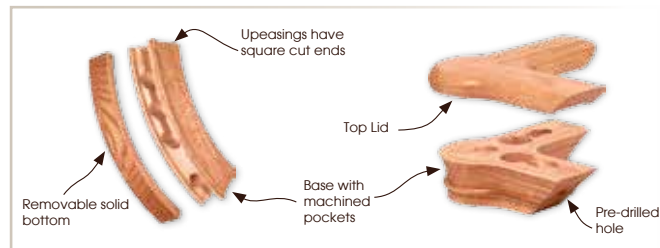

All of the Conect-A-Kit® fittings have a base with machined pockets and a removable top lid (or bottom) for easy installation. All assembly hardware is concealed within the base of each fitting.

Conect-A-Kit® Fittings for Common Stairway Applications

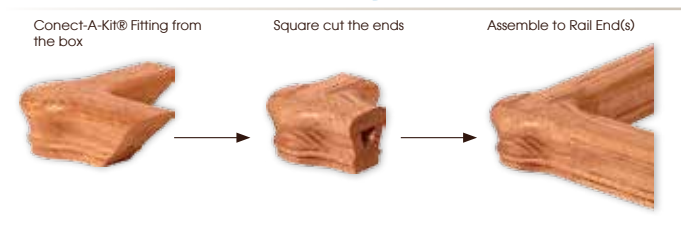

Conect-A-Kit® fittings provide several advantages:

Versatility — make left or right turns with the same fitting. Fittings can be used to make up a variety of fitting combinations.

Ease of Assembly — most joint connections are made on top of the rail system for better access. No rail bolts required!

Added Strength — the hardware included with each fitting provides greater strength and tighter connections.

Conect-A-Kit® Fittings for Building Landing Fitting Assemblies (goosenecks)

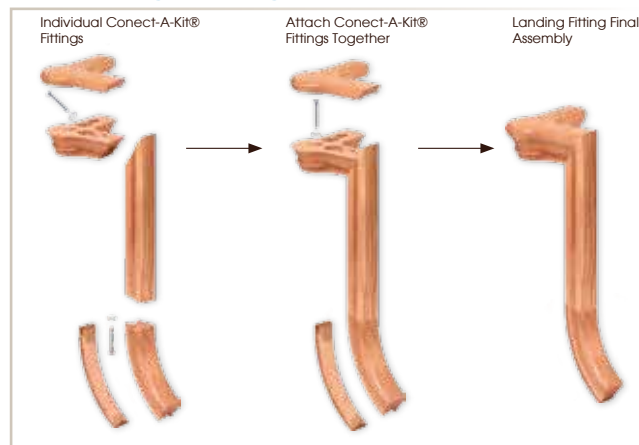

Conect-A-Kit® fittings and traditional fittings are available in the handrail profiles shown below. When the handrail chosen is plowed, designate a plowed fitting with a “P” suffix. Fillet is included with each plowed fitting. Note: some fittings are available plowed 1¼" or 1¾" and some are not available plowed at all...refer to the item numbers listed below each fitting throughout this section of the catalog.

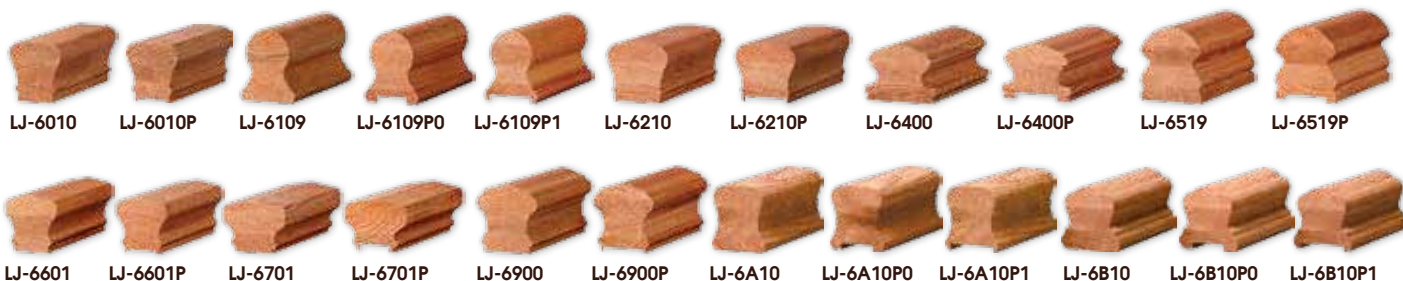

When ordering fittings to match the chosen handrail, the second digit indicates the matching profile. Below is an example of how easy it is to order our handrail fittings.



How to Install Conect-A-Kit® Fittings



Handrail Fittings

Our Conect-A-Kit® Starting Easings with Cap, Standard Volutes and Turnouts are packaged as two pieces unassembled while our traditional fittings are assembled as one piece. A template is included with each Volute and Turnout. Handing is determined by standing at the bottom of the stairs looking up the flight.

Fittings are available in the handrail profiles shown below. When the handrail chosen is plowed, designate a plowed fitting with a "P" suffix. Fillet is included with each plowed fitting. Note: some fittings are available plowed 1¼" or 1¾" and some are not available plowed at all...refer to the item numbers listed below each fitting throughout this section of the catalog. All handrail fitting photos are shown in the LJ-6010 profile.

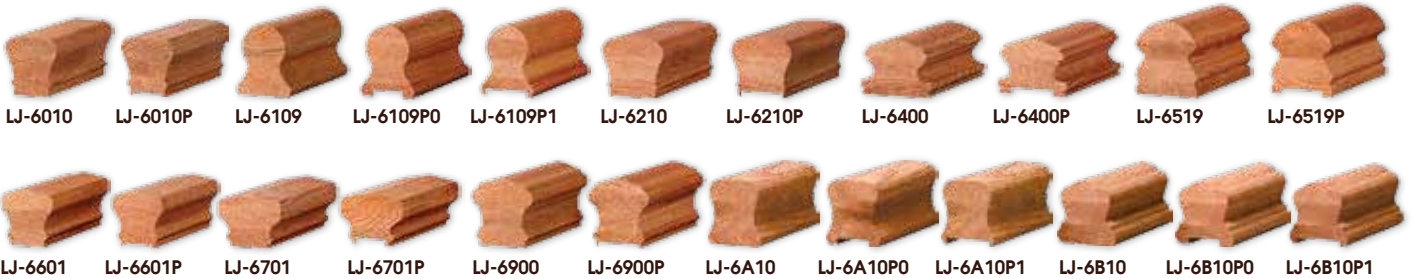

Conect-A-Kit®
Starting Easing with Cap®

Traditional
Starting Easing with Cap®

- LJ-7010 (P)(use with LJ-6010)S-7010 (P)
- LJ-7110 (P)(use with LJ-6109)S-7110 (P)
- LJ-7210 (P)(use with LJ-6210)S-7210 (P)
- LJ-7410 (P)(use with LJ-6400)S-7410 (P)
- LJ-7510 (P)(use with LJ-6519)S-7510 (P)
- LJ-7610 (P)(use with LJ-6601)S-7610 (P)
- LJ-7710 (P)(use with LJ-6701)S-7710 (P)
- LJ-7910 (P)(use with LJ-6900)S-7910 (P)
- LJ-7A10 (P)(use with LJ-6A10)S-7A10 (P)
- LJ-7B10 (P)(use with LJ-6B10)S-7B10 (P)



Traditional
Vertical Volute

- LJ-7038 (use with LJ-6010)
- LJ-7138 (use with LJ-6109)
- LJ-7238 (use with LJ-6210)
- LJ-7438 (use with LJ-6400)
- LJ-7538 (use with LJ-6519)
- LJ-7638 (use with LJ-6601)
- LJ-7738 (use with LJ-6701)
- LJ-7938 (use with LJ-6900)
- LJ-7A38 (use with LJ-6A10)
- LJ-7B38 (use with LJ-6B10)



Traditional Left Hand
Climbing Volute



Traditional Right Hand
Climbing Volute

- LJ-7031 (use with LJ-6010) LJ-7036
- LJ-7231 (use with LJ-6210) LJ-7236
- LJ-7431 (use with LJ-6400) LJ-7436
- LJ-7531 (use with LJ-6519) LJ-7536
- LJ-7631 (use with LJ-6601) LJ-7636
- LJ-7731 (use with LJ-6701) LJ-7736
- LJ-7931 (use with LJ-6900) LJ-7936
- LJ-7A31 (use with LJ-6A10) LJ-7A36
- LJ-7B31 (use with LJ-6B10) LJ-7B36



Standard Volute

4 1/2"

Climbing Volute

When using a Climbing Volute, the newel height at the volute will be approximately 4½" lower than what is produced with a standard volute. This dimension will vary with the rise and run of the stairway.

The photo to the right shows the sweeping elegance of the climbing volutes.



*These fittings are available with a 90° upsealing by adding a :90 suffix to the fitting item number. Example: LJ-7030-90



Conect-A-Kit® Left Hand Standard Volute*

LJ-7030 (P)(use with LJ-6010) LJ-7035 (P)
 LJ-7130 (P)(use with LJ-6109) LJ-7135 (P)
 LJ-7230 (P)(use with LJ-6210) LJ-7235 (P)
 LJ-7430 (P)(use with LJ-6400) LJ-7435 (P)
 LJ-7530 (P)(use with LJ-6519) LJ-7535 (P)
 LJ-7630 (P)(use with LJ-6601) LJ-7635 (P)
 LJ-7730 (P)(use with LJ-6701) LJ-7735 (P)
 LJ-7930 (P)(use with LJ-6900) LJ-7935 (P)
 LJ-7A30 (P)(use with LJ-6A10) LJ-7A35 (P)
 LJ-7B30 (P)(use with LJ-6B10) LJ-7B35 (P)



Conect-A-Kit® Right Hand Standard Volute*



Traditional Left Hand Standard Volute*

S-7030 (P)(use with LJ-6010) S-7035 (P)
 S-7130 (P)(use with LJ-6109) S-7135 (P)
 S-7230 (P)(use with LJ-6210) S-7235 (P)
 S-7430 (P)(use with LJ-6400) S-7435 (P)
 S-7530 (P)(use with LJ-6519) S-7535 (P)
 S-7630 (P)(use with LJ-6601) S-7635 (P)
 S-7730 (P)(use with LJ-6701) S-7735 (P)
 S-7930 (P)(use with LJ-6900) S-7935 (P)
 S-7A30 (P)(use with LJ-6A10) S-7A35 (P)
 S-7B30 (P)(use with LJ-6B10) S-7B35 (P)



Traditional Right Hand Standard Volute*



Conect-A-Kit® 3" Left Hand Turnout*

LJ-7041 (P)(use with LJ-6010) LJ-7046 (P)
 LJ-7141 (P)(use with LJ-6109) LJ-7146 (P)
 LJ-7241 (P)(use with LJ-6210) LJ-7246 (P)
 LJ-7441 (P)(use with LJ-6400) LJ-7446 (P)
 LJ-7541 (P)(use with LJ-6519) LJ-7546 (P)
 LJ-7641 (P)(use with LJ-6601) LJ-7646 (P)
 LJ-7741 (P)(use with LJ-6701) LJ-7746 (P)
 LJ-7941 (P)(use with LJ-6900) LJ-7946 (P)
 LJ-7A41 (P)(use with LJ-6A10) LJ-7A46 (P)
 LJ-7B41 (P)(use with LJ-6B10) LJ-7B46 (P)



Conect-A-Kit® 3" Right Hand Turnout*



Traditional 3" Left Hand Turnout*

S-7041 (P)(use with LJ-6010) S-7046 (P)
 S-7141 (P)(use with LJ-6109) S-7146 (P)
 S-7241 (P)(use with LJ-6210) S-7246 (P)
 S-7441 (P)(use with LJ-6400) S-7446 (P)
 S-7541 (P)(use with LJ-6519) S-7546 (P)
 S-7641 (P)(use with LJ-6601) S-7646 (P)
 S-7741 (P)(use with LJ-6701) S-7746 (P)
 S-7941 (P)(use with LJ-6900) S-7946 (P)
 S-7A41 (P)(use with LJ-6A10) S-7A46 (P)
 S-7B41 (P)(use with LJ-6B10) S-7B46 (P)



Traditional 3" Right Hand Turnout*



Conect-A-Kit® 5" Left Hand Turnout*

LJ-7040 (P)(use with LJ-6010) ... LJ-7045 (P)
 LJ-7140 (P)(use with LJ-6109) ... LJ-7145 (P)
 LJ-7240 (P)(use with LJ-6210) LJ-7245 (P)
 LJ-7440 (P)(use with LJ-6400) LJ-7445 (P)
 LJ-7540 (P)(use with LJ-6519) LJ-7545 (P)
 LJ-7640 (P)(use with LJ-6601) LJ-7645 (P)
 LJ-7740 (P)(use with LJ-6701) LJ-7745 (P)
 LJ-7940 (P)(use with LJ-6900) LJ-7945 (P)
 LJ-7A40 (P)(use with LJ-6A10) LJ-7A45 (P)
 LJ-7B40 (P)(use with LJ-6B10) LJ-7B45 (P)



Conect-A-Kit® 5" Right Hand Turnout*



Traditional 5" Left Hand Turnout*

S-7040 (P)(use with LJ-6010) ... S-7045 (P)
 S-7140 (P)(use with LJ-6109) ... S-7145 (P)
 S-7240 (P)(use with LJ-6210) S-7245 (P)
 S-7440 (P)(use with LJ-6400) S-7445 (P)
 S-7540 (P)(use with LJ-6519) S-7545 (P)
 S-7640 (P)(use with LJ-6601) S-7645 (P)
 S-7740 (P)(use with LJ-6701) S-7745 (P)
 S-7940 (P)(use with LJ-6900) S-7945 (P)
 S-7A40 (P)(use with LJ-6A10) S-7A45 (P)
 S-7B40 (P)(use with LJ-6B10) S-7B45 (P)



Traditional 5" Right Hand Turnout*

Handrail Fittings

The handrail fittings on these two pages are used for common stairway applications. Upeasings and Over Easings are used when the stairway rise changes. The Quarterturns are used when the rail changes direction. The Rail Drop is used to build Landing Fitting Assemblies (goosenecks). Use the "S" Shaped Fittings to continue the handrail around a partial wall.

Fittings are available in the handrail profiles shown below. When the handrail chosen is plowed, designate a plowed fitting with a "P" suffix. Fillet is included with each plowed fitting. Note: some fittings are available plowed 1¼" or 1¾" and some are not available plowed at all...refer to the item numbers listed below each fitting throughout this section of the catalog. All handrail fitting photos are shown in the LJ-6010 profile.



Conect-A-Kit®
Returned End

Traditional
Returned End

Conect-A-Kit®
Level Quarterturn 90°

Traditional
Level Quarterturn 90°

Conect-A-Kit®
Level Quarterturn 135°

Traditional
Level Quarterturn 135°

- LJ-7009 (use with LJ-6010)S-7009
- LJ-7109 (use with LJ-6109)S-7109
- LJ-7209 (use with LJ-6210)S-7209
- LJ-7409 (use with LJ-6400)S-7409
- LJ-7509 (use with LJ-6519)S-7509
- LJ-7609 (use with LJ-6601)S-7609
- LJ-7709 (use with LJ-6701)S-7709
- LJ-7909 (use with LJ-6900)S-7909
- LJ-7A09 (use with LJ-6A10)S-7A09
- LJ-7B09 (use with LJ-6B10)S-7B09

- LJ-7011 (use with LJ-6010)S-7011
- LJ-7111 (use with LJ-6109)S-7111
- LJ-7211 (use with LJ-6210)S-7211
- LJ-7411 (use with LJ-6400)S-7411
- LJ-7511 (use with LJ-6519)S-7511
- LJ-7611 (use with LJ-6601)S-7611
- LJ-7711 (use with LJ-6701)S-7711
- LJ-7911 (use with LJ-6900)S-7911
- LJ-7A11 (use with LJ-6A10)S-7A11
- LJ-7B11 (use with LJ-6B10)S-7B11

- LJ-7011-135 ... (use with LJ-6010)S-7011-135
- LJ-7111-135 ... (use with LJ-6109)S-7111-135
- LJ-7211-135 ... (use with LJ-6210)S-7211-135
- LJ-7411-135 ... (use with LJ-6400)S-7411-135
- LJ-7511-135 ... (use with LJ-6519)S-7511-135
- LJ-7611-135 ... (use with LJ-6601)S-7611-135
- LJ-7711-135 ... (use with LJ-6701)S-7711-135
- LJ-7911-135 ... (use with LJ-6900)S-7911-135
- LJ-7A11-135... (use with LJ-6A10)S-7A11-135
- LJ-7B11-135 ... (use with LJ-6B10)S-7B11-135

Custom angles are also available. Call your supplier for details.



Conect-A-Kit®
Upeasing 60°

Traditional
Upeasing 60°

Conect-A-Kit®
Upeasing 90°

Traditional
Upeasing 90°

Traditional
Over Easing 60°

- LJ-7012 (P)(use with LJ-6010)S-7012 (P)
- LJ-7112 (P)(use with LJ-6109)S-7112 (P)
- LJ-7212 (P)(use with LJ-6210)S-7212 (P)
- LJ-7412 (P)(use with LJ-6400)S-7412 (P)
- LJ-7512 (P)(use with LJ-6519)S-7512 (P)
- LJ-7612 (P)(use with LJ-6601)S-7612 (P)
- LJ-7712 (P)(use with LJ-6701)S-7712 (P)
- LJ-7912 (P)(use with LJ-6900)S-7912 (P)
- LJ-7A12 (P)(use with LJ-6A10)S-7A12 (P)
- LJ-7B12 (P)(use with LJ-6B10)S-7B12 (P)

- LJ-7014 (P)(use with LJ-6010)S-7014 (P)
- LJ-7114 (P)(use with LJ-6109)S-7114 (P)
- LJ-7214 (P)(use with LJ-6210)S-7214 (P)
- LJ-7414 (P)(use with LJ-6400)S-7414 (P)
- LJ-7514 (P)(use with LJ-6519)S-7514 (P)
- LJ-7614 (P)(use with LJ-6601)S-7614 (P)
- LJ-7714 (P)(use with LJ-6701)S-7714 (P)
- LJ-7914 (P)(use with LJ-6900)S-7914 (P)
- LJ-7A14 (P)(use with LJ-6A10)S-7A14 (P)
- LJ-7B14 (P)(use with LJ-6B10)S-7B14 (P)

- LJ-7013 (P) ... (use with LJ-6010)
- LJ-7113 (P) ... (use with LJ-6109)
- LJ-7213 (P) ... (use with LJ-6210)
- LJ-7413 (P) ... (use with LJ-6400)
- LJ-7513 (P) ... (use with LJ-6519)
- LJ-7613 (P) ... (use with LJ-6601)
- LJ-7713 (P) ... (use with LJ-6701)
- LJ-7913 (P) ... (use with LJ-6900)
- LJ-7A13 (P) ... (use with LJ-6A10)
- LJ-7B13 (P) ... (use with LJ-6B10)

**Conect-A-Kit®
Starting Easing**

- LJ-7015 (P)(use with LJ-6010) S-7015 (P)
- LJ-7115 (P)(use with LJ-6109) S-7115 (P)
- LJ-7215 (P)(use with LJ-6210) S-7215 (P)
- LJ-7415 (P)(use with LJ-6400) S-7415 (P)
- LJ-7515 (P)(use with LJ-6519) S-7515 (P)
- LJ-7615 (P)(use with LJ-6601) S-7615 (P)
- LJ-7715 (P)(use with LJ-6701) S-7715 (P)
- LJ-7915 (P)(use with LJ-6900) S-7915 (P)
- LJ-7A15 (P)(use with LJ-6A10) S-7A15 (P)
- LJ-7B15 (P)(use with LJ-6B10) S-7B15 (P)

**Traditional
Starting Easing**

**Conect-A-Kit®
Starting Over Easing**

- LJ-7016 (P)(use with LJ-6010) S-7016 (P)
- LJ-7116 (P)(use with LJ-6109) S-7116 (P)
- LJ-7216 (P)(use with LJ-6210) S-7216 (P)
- LJ-7416 (P)(use with LJ-6400) S-7416 (P)
- LJ-7516 (P)(use with LJ-6519) S-7516 (P)
- LJ-7616 (P)(use with LJ-6601) S-7616 (P)
- LJ-7716 (P)(use with LJ-6701) S-7716 (P)
- LJ-7916 (P)(use with LJ-6900) S-7916 (P)
- LJ-7A16 (P)(use with LJ-6A10) S-7A16 (P)
- LJ-7B16 (P)(use with LJ-6B10) S-7B16 (P)

**Traditional
Starting Over Easing**

**Conect-A-Kit®
Tandem Cap**

- LJ-7020(use with LJ-6010) S-7020
- LJ-7120(use with LJ-6109) S-7120
- LJ-7220(use with LJ-6210) S-7220
- LJ-7420(use with LJ-6400) S-7420
- LJ-7520(use with LJ-6519) S-7520
- LJ-7620(use with LJ-6601) S-7620
- LJ-7720(use with LJ-6701) S-7720
- LJ-7920(use with LJ-6900) S-7920
- LJ-7A20(use with LJ-6A10) S-7A20
- LJ-7B20(use with LJ-6B10) S-7B20

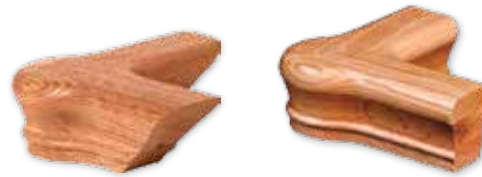
**Traditional
Tandem Cap**

**Conect-A-Kit®
Quarterturn with Cap 90°**

- LJ-7021(use with LJ-6010) S-7021
- LJ-7121(use with LJ-6109) S-7121
- LJ-7221(use with LJ-6210) S-7221
- LJ-7421(use with LJ-6400) S-7421
- LJ-7521(use with LJ-6519) S-7521
- LJ-7621(use with LJ-6601) S-7621
- LJ-7721(use with LJ-6701) S-7721
- LJ-7921(use with LJ-6900) S-7921
- LJ-7A21(use with LJ-6A10) S-7A21
- LJ-7B21(use with LJ-6B10) S-7B21

**Traditional
Quarterturn with Cap 90°**

**Conect-A-Kit®
Rail Drop**

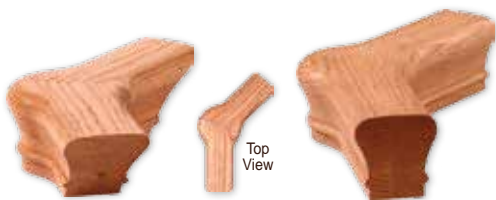
- LJ-70RD(use with LJ-6010)
- LJ-71RD(use with LJ-6109)
- LJ-72RD(use with LJ-6210)
- LJ-74RD(use with LJ-6400)
- LJ-75RD(use with LJ-6519)
- LJ-76RD(use with LJ-6601)
- LJ-77RD(use with LJ-6701)
- LJ-79RD(use with LJ-6900)
- LJ-7ARD(use with LJ-6A10)
- LJ-7BRD(use with LJ-6B10)

**Conect-A-Kit®
Quarterturn with Cap 135°**

- LJ-7021-135 ... (use with LJ-6010) S-7021-135
- LJ-7121-135 ... (use with LJ-6109) S-7121-135
- LJ-7221-135 ... (use with LJ-6210) S-7221-135
- LJ-7421-135 ... (use with LJ-6400) S-7421-135
- LJ-7521-135 ... (use with LJ-6519) S-7521-135
- LJ-7621-135 ... (use with LJ-6601) S-7621-135
- LJ-7721-135 ... (use with LJ-6701) S-7721-135
- LJ-7921-135 ... (use with LJ-6900) S-7921-135
- LJ-7A21-135 ... (use with LJ-6A10) S-7A21-135
- LJ-7B21-135 ... (use with LJ-6B10) S-7B21-135

**Traditional
Quarterturn with Cap 135°**

Traditional Coped End

- LJ-7008(use with LJ-6010)
- LJ-7208(use with LJ-6210)
- LJ-7A08 ... (use with LJ-6A10)



The Coped End and Opening Cap may be attached on the job using a rail bolt to accommodate almost any angle.

**Conect-A-Kit®
Opening Cap**

- LJ-7019(use with LJ-6010) S-7019
- LJ-7119(use with LJ-6109) S-7119
- LJ-7219(use with LJ-6210) S-7219
- LJ-7419(use with LJ-6400) S-7419
- LJ-7519(use with LJ-6519) S-7519
- LJ-7619(use with LJ-6601) S-7619
- LJ-7719(use with LJ-6701) S-7719
- LJ-7919(use with LJ-6900) S-7919
- LJ-7A19(use with LJ-6A10) S-7A19
- LJ-7B19(use with LJ-6B10) S-7B19

**Traditional
Opening Cap**

Custom angles are also available. Call your supplier for details.







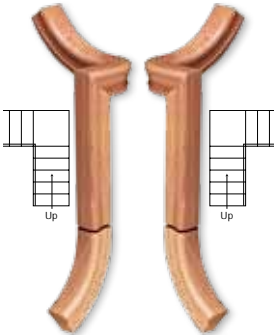
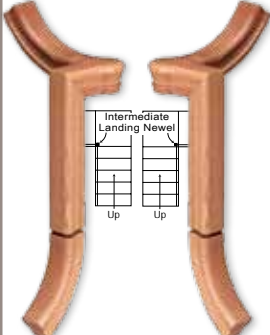
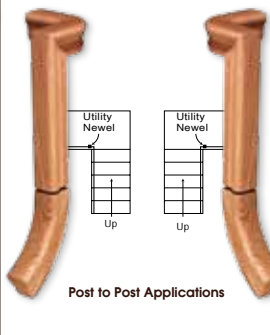
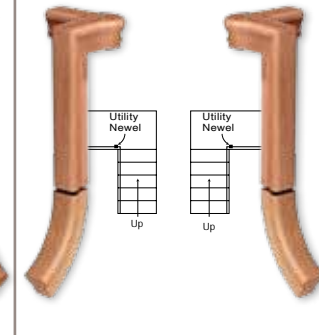

**Traditional Left Hand
"S" Shaped Fitting**

- LJ-7047 (use with LJ-6010)LJ-7048
- LJ-7147 (use with LJ-6109)LJ-7148
- LJ-7247 (use with LJ-6210)LJ-7248
- LJ-7447 (use with LJ-6400)LJ-7448
- LJ-7547 (use with LJ-6519)LJ-7548
- LJ-7647 (use with LJ-6601)LJ-7648
- LJ-7747 (use with LJ-6701)LJ-7748
- LJ-7947 (use with LJ-6900)LJ-7948
- LJ-7A47 ... (use with LJ-6A10)LJ-7A48
- LJ-7B47 (use with LJ-6B10)LJ-7B48





**Traditional Right Hand
"S" Shaped Fitting**

Handrail Fittings

We offer traditional 2-rise gooseneck fittings shown on the top of these two pages. Goosenecks (Landing Fitting Assemblies) can also be assembled from various combinations of the seven Conect-A-Kit component fittings shown along the left edge of this page. Use the chart on these two pages to determine which

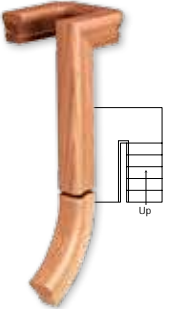
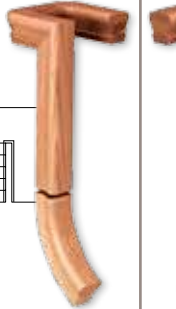
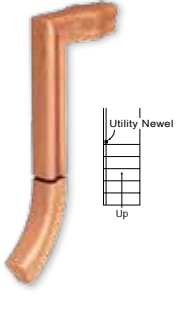
<p>How to use this chart — Each box to the right shows a group of traditional gooseneck fittings. The rows below each group indicate which Conect-A-Kit component fittings, and how many of each, are required to build <u>any</u> one of the corresponding gooseneck fittings in the group. After you've determined which component fittings are needed, refer to pages 75-76 for the respective fitting part numbers to match your chosen handrail.</p>								
	Traditional LH Gooseneck	Traditional RH Gooseneck	Traditional LH Gooseneck	Traditional RH Gooseneck	Traditional LH Gooseneck	Traditional RH Gooseneck	Traditional LH Gooseneck	Traditional RH Gooseneck
	<p>S-7050(use with LJ-6010) ... S-7055 S-7150(use with LJ-6109) ... S-7155 S-7250(use with LJ-6210) ... S-7255 S-7450(use with LJ-6400) ... S-7455 S-7550(use with LJ-6519) ... S-7555 S-7650(use with LJ-6601) ... S-7655 S-7750(use with LJ-6701) ... S-7755 S-7950(use with LJ-6900) ... S-7955 S-7A50(use with LJ-6A10) ... S-7A55 S-7B50(use with LJ-6B10) ... S-7B55</p>	<p>S-7060(use with LJ-6010) ... S-7065 S-7160(use with LJ-6109) .. S-7165 S-7260(use with LJ-6210) ... S-7265 S-7460(use with LJ-6400) ... S-7465 S-7560(use with LJ-6519) ... S-7565 S-7660(use with LJ-6601) ... S-7665 S-7760(use with LJ-6701) ... S-7765 S-7960(use with LJ-6900) ... S-7965 S-7A60(use with LJ-6A10) .. S-7A65 S-7B60(use with LJ-6B10) ... S-7B65</p>	<p>S-7071(use with LJ-6010) ... S-7076 S-7171(use with LJ-6109) ... S-7176 S-7271(use with LJ-6210) ... S-7276 S-7471(use with LJ-6400) ... S-7476 S-7571(use with LJ-6519) ... S-7576 S-7671(use with LJ-6601) ... S-7676 S-7771(use with LJ-6701) ... S-7776 S-7971(use with LJ-6900) ... S-7976 S-7A71(use with LJ-6A10) ... S-7A76 S-7B71(use with LJ-6B10) ... S-7B76</p>	<p>S-7081(use with LJ-6010) ... S-7086 S-7181(use with LJ-6109) ... S-7186 S-7281(use with LJ-6210) ... S-7286 S-7481(use with LJ-6400) ... S-7486 S-7581(use with LJ-6519) ... S-7586 S-7681(use with LJ-6601) ... S-7686 S-7781(use with LJ-6701) ... S-7786 S-7981(use with LJ-6900) ... S-7986 S-7A81(use with LJ-6A10) ... S-7A86 S-7B81(use with LJ-6B10) ... S-7B86</p>				
 Conect-A-Kit Returned End LJ-7X09								
 Conect-A-Kit Quarterturn 90° LJ-7X11	1				1			
 Conect-A-Kit Upcasing 60° LJ-7X12	2	2			1	1		
 Conect-A-Kit Opening Cap LJ-7X19								
 Conect-A-Kit Tandem Cap LJ-7X20								
 Conect-A-Kit Quarterturn w/Cap LJ-7X21			1				1	
 Conect-A-Kit Rail Drop LJ-7XRD	1	1			1		1	

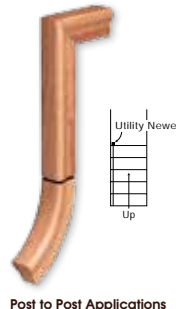
Conect-A-Kit fittings to order for making the corresponding goosenecks (Landing Fitting Assemblies) shown across the top.

 <p>Traditional LH Gooseneck</p> <p>S-7090-2..... (use with LJ-6010) S-7095-2 S-7190-2..... (use with LJ-6109) S-7195-2 S-7290-2..... (use with LJ-6210) S-7295-2 S-7490-2..... (use with LJ-6400) S-7495-2 S-7590-2..... (use with LJ-6519) S-7595-2 S-7690-2..... (use with LJ-6601) S-7695-2 S-7790-2..... (use with LJ-6701) S-7795-2 S-7990-2..... (use with LJ-6900) S-7995-2 S-7A90-2..... (use with LJ-6A10) S-7A95-2 S-7B90-2..... (use with LJ-6B10) S-7B95-2</p>	 <p>Traditional RH Gooseneck</p> <p>S-7091-2..... (use with LJ-6010) S-7092-2 S-7191-2..... (use with LJ-6109) S-7192-2 S-7291-2..... (use with LJ-6210) S-7292-2 S-7491-2..... (use with LJ-6400) S-7492-2 S-7591-2..... (use with LJ-6519) S-7592-2 S-7691-2..... (use with LJ-6601) S-7692-2 S-7791-2..... (use with LJ-6701) S-7792-2 S-7991-2..... (use with LJ-6900) S-7992-2 S-7A91-2..... (use with LJ-6A10) S-7A92-2 S-7B91-2..... (use with LJ-6B10) S-7B92-2</p>	 <p>Traditional Tandem Cap Gooseneck</p> <p>S-7088-2..... (use with LJ-6010) S-7188-2..... (use with LJ-6109) S-7288-2..... (use with LJ-6210) S-7488-2..... (use with LJ-6400) S-7588-2..... (use with LJ-6519) S-7688-2..... (use with LJ-6601) S-7788-2..... (use with LJ-6701) S-7988-2..... (use with LJ-6900) S-7A88-2..... (use with LJ-6A10) S-7B88-2..... (use with LJ-6B10)</p>	 <p>Traditional Cap Gooseneck</p> <p>S-7097..... (use with LJ-6010) S-7197..... (use with LJ-6109) S-7297..... (use with LJ-6210) S-7497..... (use with LJ-6400) S-7597..... (use with LJ-6519) S-7697..... (use with LJ-6601) S-7797..... (use with LJ-6701) S-7997..... (use with LJ-6900) S-7A97..... (use with LJ-6A10) S-7B97..... (use with LJ-6B10)</p>	 <p>Traditional Gooseneck</p> <p>S-7099..... (use with LJ-6010) S-7199..... (use with LJ-6109) S-7299..... (use with LJ-6210) S-7499..... (use with LJ-6400) S-7599..... (use with LJ-6519) S-7699..... (use with LJ-6601) S-7799..... (use with LJ-6701) S-7999..... (use with LJ-6900) S-7A99..... (use with LJ-6A10) S-7B99..... (use with LJ-6B10)</p> <p>Post to Post Applications</p>	
					1
2		1			
1		1	1	1	1
				1	
			1		
		1			
1		1	1	1	1

We offer a wide variety of Starting Steps to accommodate nearly any application. Each step is shipped with the necessary cove and shoe moulding. The standard length is 48" (1219 mm), however, longer lengths are also available. Single bullnose steps are reversible and can be job cut for shorter lengths. Specifications: Treads are 1" (25 mm) x 11 1/2" (292 mm); total rise on all steps is 8" (203 mm); risers measure 3/4" (19 mm) x 7" (178 mm).

Steps for use with Volutes and Turnouts — For LJ-6010, LJ-6210, LJ-6601, LJ-6900, LJ-6A10, LJ-6B10 turnouts and standard volutes, and LJ-6701 turnouts, use LJ-8010, LJ-8015, LJ-8210, and LJ-8215 starting steps. For LJ-6109, LJ-6400, LJ-6519 turnouts and standard volutes, LJ-6701 standard volutes, and all climbing volutes, use LJ-8310 and LJ-8315 starting steps.

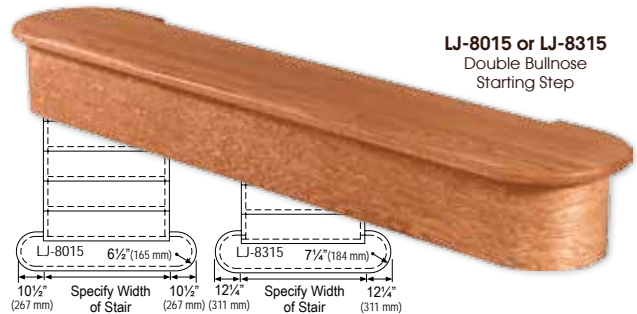
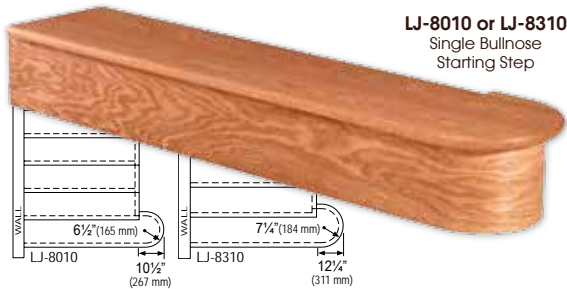

Steps for use with Square Top Newels, Box Newels and 90 Starting Fittings — For Box Newels or when placing any square top utility newel at the second riser, use LJ-8040 and LJ-8060 steps. For starting fittings utilizing a 90° up easing, as illustrated to the right, use LJ-8440, LJ-8460, LJ-8640 and LJ-8660 steps. For LJ-6010, LJ-6210, LJ-6601, LJ-6A10, LJ-6B10 profiles of turnouts and standard volutes, or LJ-6109 and LJ-6701 turnouts, use LJ-8440 and LJ-8460 steps. For LJ-6109, LJ-6701 standard volutes, or LJ-6519, LJ-6400 and LJ-6900 turnouts and standard volutes, use LJ-8640 and LJ-8660 steps.

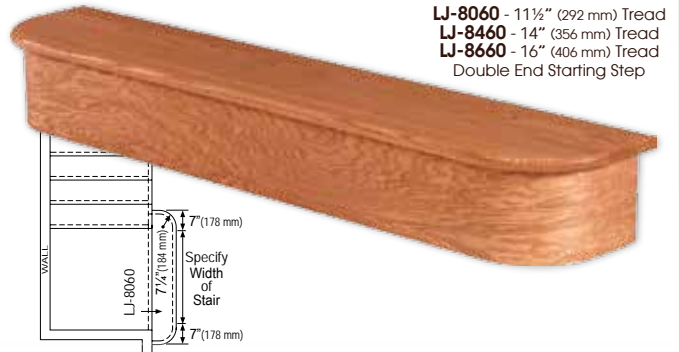
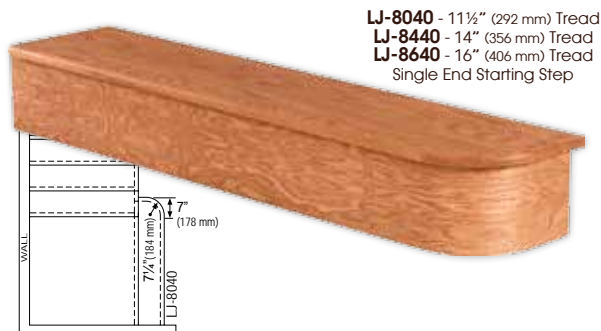
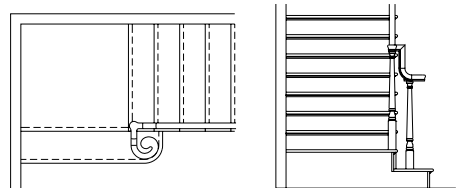

Starting Steps for use with Box Newels — Our LJ-8030 and LJ-8050 steps are for use with any of our Box Newels.

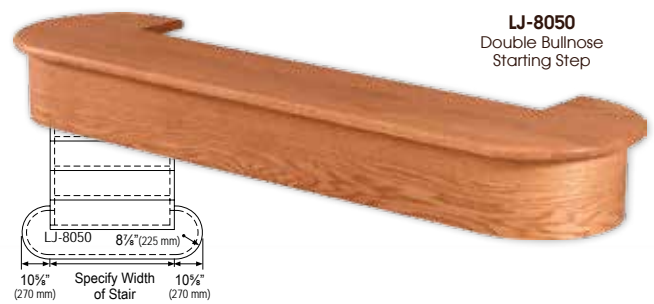
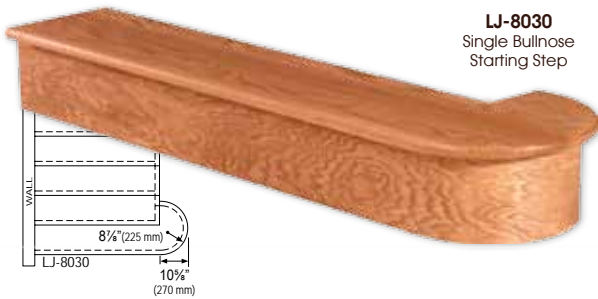

Treads, Risers, Skirtboard and Mouldings — Our treads (except hybrid treads) and risers are available in 36" (914 mm), 42" (1067 mm), 48" (1219 mm), 54" (1372 mm), 60" (1524 mm) and 72" (1829 mm) lengths. See descriptions below the other products for their available lengths.



Hybrid treads are for use on stairways that will receive carpeting over the treads and risers, leaving the end of the tread exposed



LJ-8070MR1 Reversible*
LJ-8870MR1 Reversible†*
Tread with Miter Return on one end, but is reversible for LH or RH
All above are 1" x 10 1/2" or 11 1/2" (25 mm x 267 mm or 292 mm)

† Tread with Square Nose
1" x 11 1/2"
(25 mm x 292 mm)

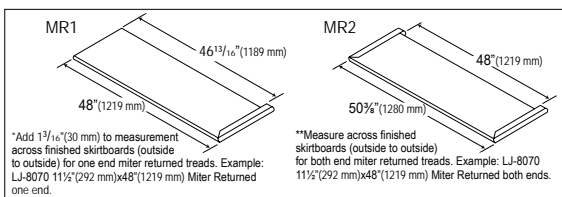
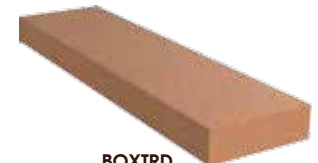

Rosettes & Brackets

Rosettes — We have designed our rosettes to accommodate nearly any of our handrail profiles. Rosettes are used to cap off handrail any time it ends at a wall.



Side Profile of each Rosette
3/4" thick
(19 mm)



LJ-7033
6" x 4 5/16"
(152 mm x 110 mm)



LJ-7026
4 7/16" Round
(116 mm)



LJ-7027
6 1/2" x 4 7/16"
(165 mm x 113 mm)

Stair Brackets — These decorative brackets upgrade any open tread stair with their delicate detail.



LJ-7028
11 1/2" x 8 1/8" x 5/16"
(292 mm x 206 mm x 8 mm)



LJ-7029
11 1/2" x 8 1/8" x 5/16"
(292 mm x 206 mm x 8 mm)

False Tread Kit Applications

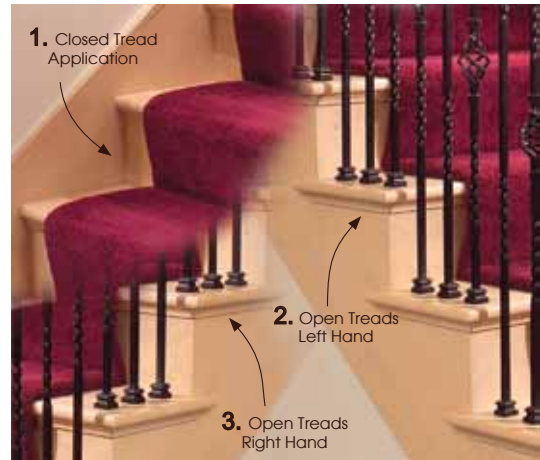

1. Closed Tread Application

2. Open Treads Left Hand

3. Open Treads Right Hand

False Ends — False Starting Steps and False Treads and Risers are often used when carpeting will be placed on the center of the treads and risers on a stairway. We offer a variety of kits for finishing off your stairway treads.



A false end step is used when a volute or turnout is utilized at the bottom of the stairway. Each kit includes cove and shoe moulding, and is reversible for right hand and left hand applications.

LJ-8010-2
False End Starting Step

Use with the same starting fittings as is used with our LJ-8010 full starting step (see page 79)

LJ-8310-2
False End Starting Step

Use with the same starting fittings as is used with our LJ-8310 full starting step (see page 79)



LJ-8079
False Tread Kit

This kit can accommodate applications 1, 2, or 3 pictured above. Tread is 11" x 6" x 1/2" (279 mm x 152 mm x 13 mm)
Riser is 8" x 6" x 1/2" (203 mm x 152 mm x 13 mm)



LJ-8179
Double Miter Return False Tread Kit

This kit can accommodate applications 2 & 3, as pictured above. Tread with attached moulding is 12 1/2" x 7 1/4" (318 mm x 184 mm)
Riser is 8" x 6" x 1/2" (203 mm x 152 mm x 13 mm)



LJ-8078
Lineal False Tread Moulding

1 1/4" (32 mm) x 1 13/16" (21 mm) x random length



LJ-8172
Closed False Tread Kit

This kit can accommodate application 1, as pictured above. Tread with attached moulding is 12 1/4" x 6" (311 mm x 152 mm)
Riser is 8" x 6" x 1/2" (203 mm x 152 mm or 13 mm)



LJ-8879
Double Miter Return False Tread Kit

This kit can accommodate applications 1, 2 or 3, as pictured above. Tread with attached moulding is 12 5/8" x 7 5/16" (321 mm x 186 mm)
Riser is 7 3/4" x 6 1/2" x 1/2" (197 mm x 165 mm x 13 mm)



S-8071RH
Right Hand False Tread

Use with LJ-8076 to accommodate application 3 pictured above. 13 7/8" x 5 1/4" (352 mm x 133 mm)



S-8071LH
Left Hand False Tread

Use with LJ-8076 to accommodate application 2 pictured above. 13 7/8" x 5 1/4" (352 mm x 133 mm)

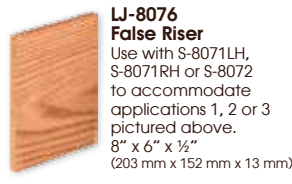

LJ-8076
False Riser

Use with S-8071LH, S-8071RH or S-8072 to accommodate applications 1, 2 or 3 pictured above. 8" x 6" x 1/2" (203 mm x 152 mm x 13 mm)



S-8072
False Tread

Use with LJ-8076 to accommodate application 1 pictured above. 13 7/8" x 5 1/4" (352 mm x 133 mm)

Bending Rails

Bending Rail — Many of our handrail profiles shown throughout this catalog are available in bending rail for applications requiring curved handrail. Corresponding bending mould to match the chosen handrail is necessary for forming the desired radius. Bending moulds are available separately in random lengths. Our bending rails are available in 8', 10', 12', 14', & 16' lengths. The dimensions of each of our bending rails match their corresponding straight rail profile. Our bending rails are shown below along with the rake and level radius limitations to which each can be bent.



LJ-6010B
7 pieces
Bending Radius:
Rake - 30" (762 mm)
Level - 36" (914 mm)

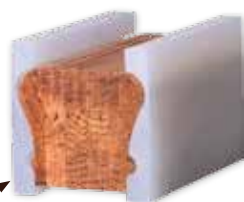

LJ-6210B
8 pieces
Bending Radius:
Rake - 30" (762 mm)
Level - 36" (914 mm)

LJ-6010BM or LJ-6910BM*
Bending Mould for
LJ-6010B or LJ-6210B



LJ-6109B
9 pieces
Bending Radius:
Rake - 36" (914 mm)
Level - 48" (1219 mm)

Does not require
Bending Mould



LJ-6519B
7 pieces
Bending Radius:
Rake - 54" (1372 mm)
Level - 60" (1524 mm)

LJ-6519BM
Pine Bending Mould
for LJ-6519B



LJ-6601B
7 pieces
Bending Radius:
Rake - 30" (762 mm)
Level - 36" (914 mm)

LJ-6601BM
Pine Bending Mould
for LJ-6601B



LJ-6701B
10 pieces
Bending Radius:
Rake - 30" (762 mm)
Level - 36" (914 mm)

LJ-6701BM
Pine Bending Mould
for LJ-6701B



LJ-6900B
8 pieces
Bending Radius:
Rake - 54" (1372 mm)
Level - 60" (1524 mm)

LJ-6900BM
Pine Bending Mould
for LJ-6900B



LJ-6A10B
7 pieces
Bending Radius:
Rake - 30" (762 mm)
Level - 36" (914 mm)

LJ-6A10BM
Pine Bending Mould
for LJ-6A10B



LJ-6B10B
7 pieces
Bending Radius:
Rake - 36" (914 mm)
Level - 48" (1219 mm)

LJ-6B10BM*
Bending Mould
for LJ-6B10B

*LJ-6910BM and LJ-6B10BM Enduromolds are reusable polyvinyl bending moulds. Glue does not stick to the surface. Both profiles are available in 8' (2438 mm) lengths only.



Bending rails are typically used on circular or spiral stairs, and curved balconies.

Pictured Left: This elegant stair features LJ-6900B Bending Handrail and Climbing Volutes with LJB-2915 Beaded Balusters and LJB-3910 Beaded Newel Posts.

Pictured Right: Highlighted in this classic stairway design is LJ-6519B Bending Handrail and Climbing Volute with LI-14044, LI-15044, LI-14344, LI-30144 Iron Balusters, and LJF-3010 Fluted Newel Posts.



Wall Rails

Wall Rail — We offer four profiles of wall rail and corresponding fittings for three of the profiles. Wall rail is used along the wall(s) of stairways that have a full or partial wall on one or both sides. Wall rail brackets are utilized for attaching wall rail to the wall.





Wall Rail Brackets — Our wide variety of wall rail brackets provide several styles and many finishes from which to choose. The measurement from the wall to the handrail centerline on LJ-3012 and LJ-3127 brackets is 2 3/4" (70 mm) and LJ-3128 is 3 1/4" (83 mm). NOTE: Finish color may vary.

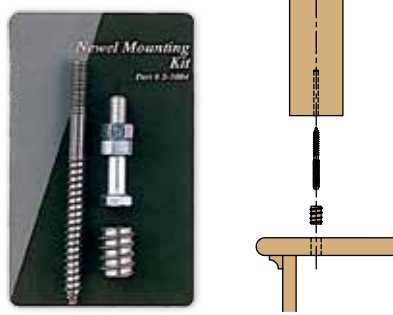
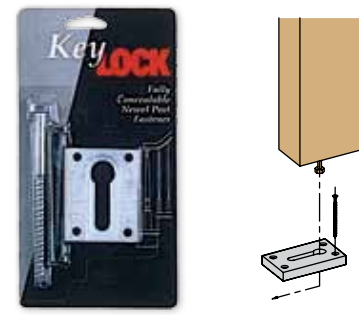
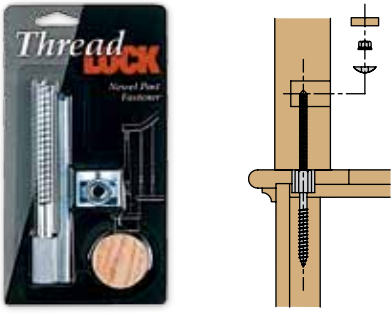
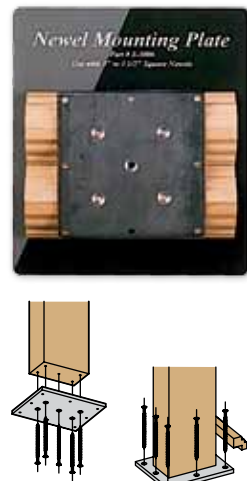
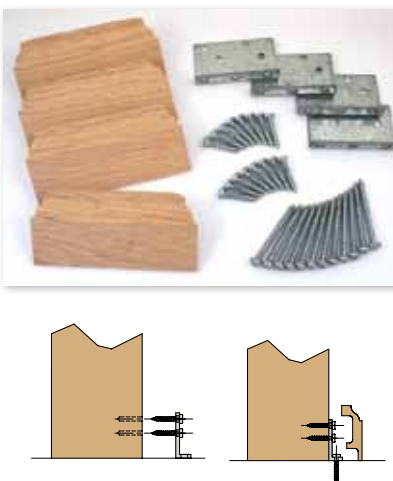
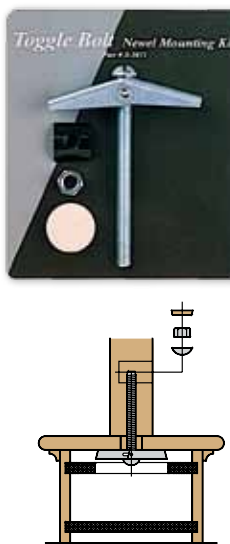
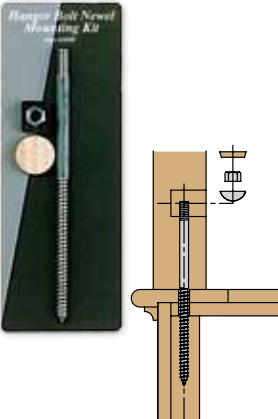
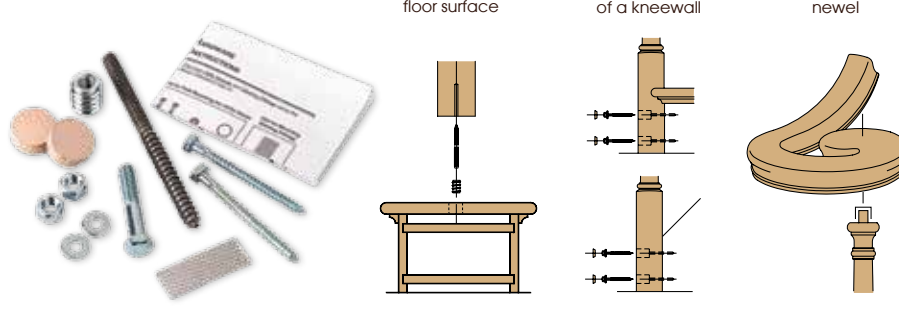

L.J. Smith offers a full line of installation hardware designed specifically for stair installers to improve the strength and quality of L.J. Smith stairway installations.

Newel Mounting Hardware

 <p>LJ-3004 Newel Mounting Kit — This kit is fully concealable. Use on finished floor surfaces, landings, and starting steps.</p>	 <p>LJ-3005 Keylock™ Newel Post Fastener — This kit is fully concealable. Use on finished floor surfaces, stairs, ceramic tile and concrete.</p>	 <p>LJ-3070 Threadlock™ Newel Post Fastener — Use to mount newel posts on finished floor surfaces.</p>	
 <p>LJ-3006 Newel Mounting Plate — Use to mount 3" (76 mm) to 3½" (89 mm) newel posts on finished floor surfaces.</p>	 <p>LJ-3009 (for 3" (76 mm) newels) LJ-3019 (for 3½" (89 mm) newels) Angle Bracket Newel Post Fastener — Use to mount newel posts on finished floor surfaces.</p>	 <p>LJ-3071 Toggle Bolt Newel Mounting Kit — Use to mount newel posts on starting steps.</p>	 <p>LJ-3008 (16" (406 mm) lag bolt) LJ-3008-10 (10¾" (273 mm) lag bolt) Hanger Bolt Newel Mounting Kit — Use to mount newel posts on finished floor surfaces.</p>
<p>LJ-3007HDWE Hardware Kit — This kit includes a variety of hardware used to install a utility newel and a starting fitting.</p> <p>Use to flush mount the utility newel on a starting step or other finished floor surface</p> <p>Use to face mount the utility newel to the face of the riser or end of a kneewall</p> <p>Use the perforated metal strip to attach the starting fitting to the utility newel</p> 			<p>LJ-3077 Rails2Post Connector™ — Use this kit to connect two rails to a post to post newel on a level run. It is simple to use and provides a quicker and stronger installation than rail bolts.</p> 

L.J. Smith offers a full line of installation hardware and tools designed specifically for stair installers to improve the strength and quality of L.J. Smith stairway installations.

Miscellaneous Hardware

 <p>LJ-3075 Flush Mount Kit — Use to fasten handrail to newels in flush mount applications.</p>	 <p>LJ-3076 Dowel-Fast Screws — Pack of 50 5/16" x 2 1/2" full threaded screws to attach balusters to treads and landing tread.</p>	 <p>LJ-3078 Rail & Post Fastener — Use to fasten handrails to newel posts or newel posts to stair risers.</p>
 <p>LJ-3079* LJ-3080 (10 Pack) Rail Bolt Kit(s) Use to attach handrail to: handrail, fitting, newel, wall; or fittings to fittings. *To order items separately use: LJ-3001 for bolt, washer and nut and use LJ-3000 for plug.</p>	 <p>LJ-3020 LJ-3021 (10 Pack) Wood Glue Aliphatic resin in Pressure Point syringe for neat and accurate placement of glue.</p>	 <p>LJ-3022 LJ-3023 (10 Pack) Realwood Water-based putty in Pressure Point syringe fills defects, cracks and nail holes.</p>
 <p>LJ-3024 (100 Pack) 1/2" (13 mm) Tapered Plugs LJ-3025 (25 Pack) 1" (25 mm) Tapered Plugs Face grain tapered plugs are designed for flush mount installations to cover bolt holes in handrail and newel posts.</p>	 <p>LJ-3026 (50 Pack) 1/2" (13 mm) Button Plugs Face grain button plugs are used to cover bolt holes in newel posts.</p>	 <p>LJ-3074 (16 Pack) Mr. Grip™ These perforated metal strips provide an extremely tight fit between handrail fittings and Over the Post newel posts.</p>

Tread & Riser Layout Tool





 <p>1. Create template using the Stair Wizard™</p> <p>2. Mark the tread using the Stair Wizard™ as the template</p>	<p>LJ-3052 Stair Wizard™ — This innovative tool allows tread installations to be done in half the time of traditional methods. Our Stair Wizard™ creates an exact template for each tread (or riser), including length, end angles and depth. It's particularly useful for out of square stairs. Simply scribe the tread blank along the template outline and trim the tread. The Stair Wizard™ accommodates stair treads up to 14" (356 mm) deep and 53" (1346 mm) wide. See below for extensions that can be purchased to increase the width capacity by 18" (457 mm) increments.</p> <p>LJ-3053 Extensions — These extensions quickly increase the stair width capacity of the Stair Wizard™. Simply splice on the required number of extensions and use the tool in the normal manner. Available sets of two.</p> 
--	--

L.J. Smith offers a variety of tools designed specifically for stair installers in order to make marking and installing balusters easier and quicker.

Baluster Marking and Installation Tools

 <p>LJ-3035 Centaur® — Centers 9/32" (7 mm) hole in baluster bases for our Dowel-Fast screws. Fits 1 1/4" (32 mm) and 1 3/4" (44 mm) balusters. Doubles as a drill bit guide and a centering device.</p>	<p>LJ-3047 Telescoping Baluster Marking Tool — Use for marking baluster locations beneath handrails. Equipped with a bubble level, rule and a 1/2" (13 mm) X 5/8" (16 mm) extension which extends from 28" (711 mm) to 42" (1067 mm). Pat. No. 5,414,942</p> 	 <p>C-88 Baluster Centerline Tool — This handy steel tool is used for quick and accurate determination of 1/4" (32 mm) and 1/4" (44 mm) baluster centerlines on the treads of open tread stairways.</p>
--	--	---

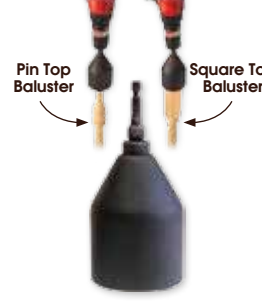
Baluster Runners™ — Our Baluster Runners™ make installing balusters on open treads and level runs a breeze because they utilize the speed of a drill. Simply insert the special 3/8" socket driver (included) into one of the Baluster Runners™ and then chuck into any 3/8" or larger power drill. After running the baluster into the tread or landing using the Baluster Runner™, our handy Baluster Wrench quickly squares the baluster up. We offer a Baluster Runner™ for 1 1/4" (32 mm) balusters and another for 1 3/4" (44 mm) balusters and each can be used on either pin top or square top balusters. The Runners and Baluster Wrench are each sold separately, or as a set. Patent Pending.







 <p>LJ-3084 1 1/4" & 1 3/4" Baluster Runner™ Set</p>	 <p>LJ-3084-1 1 1/4" Baluster Runner™</p>	 <p>LJ-3084-2 1 3/4" Baluster Runner™</p>	 <p>LJ-3084-3 Baluster Wrench</p>
--	---	--	---

ZipBolt Hardware and Tools

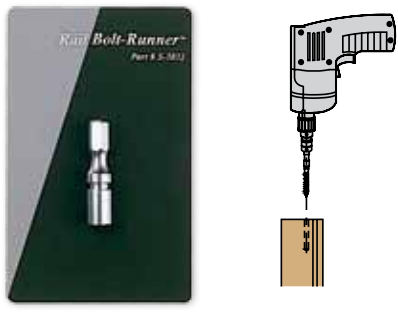
 <p>ZIPBOLT ANGLED SF2 (2 Pack) — Connects rake handrail to newel.</p>	 <p>ZIPBOLT ANGLED ZIPBOLT ANGLED2 (2 Pack) Connects rake handrail to newel.</p>	 <p>ZIPBOLT SLIPFIX2 (2 Pack) — Connects level handrail to newel.</p>
 <p>ZIPBOLT RAILBOLT ZIPBOLT RAILBOLT2 (2 Pack) Connects handrail to fitting or handrail to handrail.</p>	 <p>ZIPBOLT DRILL GUIDE Use to align and drill ZipBolt connection holes.</p>	 <p>ZIPBOLT DRIVER — Fits all ZipBolt connectors and is used in place of an allen wrench.</p>

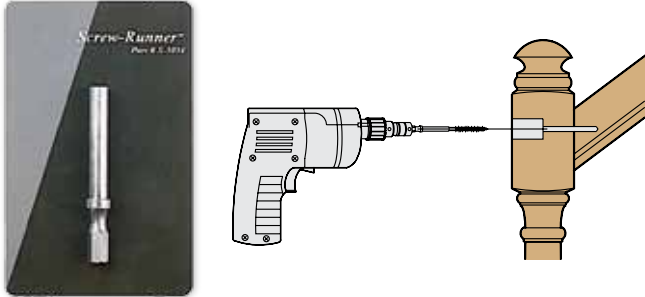
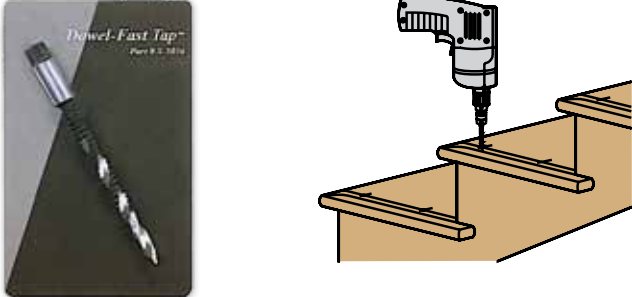
L.J. Smith offers a variety of power drill accessories designed specifically for stair installers. Our unique Chuck-Buster is a “must have” for every stair installer. This nifty tool will save valuable time on every stair installation because it eliminates the handling of multiple drills. Most of the drill tools needed to install stairs are right here on this page. Our Chuck-Buster quickly connects and releases all of them in any 3/8” or larger chuck drill.

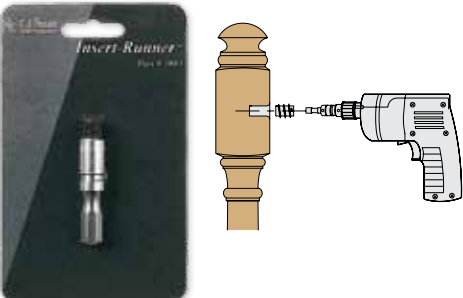
Chuck-Buster Tools

 <p>LJ-3031 Chuck-Buster — Quickly connects and releases many tools from 3/8” or larger chucks. Saves time by eliminating additional drills.</p>	 <p>LJ-3032 Rail Bolt-Runner — This drill attachment has machine threads to drive rail bolts into handrail, fittings, newels, and walls.</p>	 <p>LJ-3033 Dowel-Runner® — This drill attachment has lag threads to drive dowel screws into baluster bases.</p>
 <p>LJ-3034 Screw-Runner — This 4” drill extension has a magnetic end which fits 1/4” hex screw tips. This tool provides ease in driving wood screws into newel posts.</p>	 <p>LJ-3036 Dowel-Fast Tap — This time-saving tool drills and taps holes for ease of tightening dowel-screwed balusters into treads and landing treads.</p>	
 <p>LJ-3041 Scraper Sharpener — Use this tool to quickly sharpen any of our handrail scraper profiles found on the following page. Patent No. 5,440,811</p>	 <p>LJ-3085 Insert-Runner — Use this drill attachment with our LJ-3075 Flush Mount Kit and LJ-3004 Newel Mounting Kit to drive the 3/4”x1” threaded insert into the appropriate surface.</p>	 <p>LJ-3049 Drill Bit Pack — Includes a variety of drill bit sizes required for most stair installations.</p> <p>Includes our Chuck-Buster & Dowel-Fast Tap Includes these twist bits: 1/8”x6”, 5/32”x3 1/2”, 3/16”x3 1/2”, 3/8”x8”, 9/32”x4” Includes these spade bits: 1/2”x5”, 9/16”x5”, 5/8”x5”, 1”x5”, 1 1/2”x5”, 3/4”x5”, and a 5/8”x3” flare bit.</p>

L.J. Smith offers a full line of installation hardware and tools designed specifically for stair installers to improve the strength and quality of L.J. Smith stairway installations.

Handrail & Fitting Tools



LJ-3044 VersaTool™ — Locates holes as well as starts and tightens hex nuts onto rail bolts. Drives 5/16" rail bolts and tightens 1/2" hex nuts. Also used to locate 1/4" pilot hole on handrails & rail drops for attaching to Conect-A-Kit® handrail fittings.



Scrapers — Use to smooth profiles of handrail when two pieces are connected together. Great for clean-up on bending rail. Pat. No 5,440,811

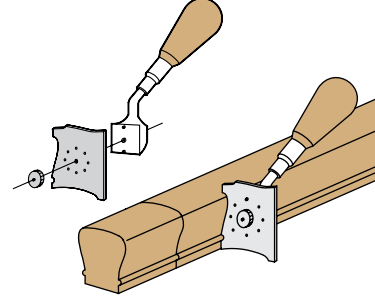

LJ-3043 Scraper Handle — Our scraper handle offers a higher level of control when using any of our scrapers. Pat. No. 5,440,811

- | | | | | |
|--|---|---|---|--|
| LJ-3040-6010
LJ-6010 & LJ-6210
Profiles | LJ-3040-6109
LJ-6109
Profile | LJ-3040-6400
LJ-6400
Profile | LJ-3040-6519
LJ-6519
Profile | LJ-3040-6701
LJ-6701 & LJ-6601
Profiles |
|--|---|---|---|--|

LJ-3060 Bore Buster® — The Bore Buster® increases the quality and speed of handrail installation. This tool bores precision perpendicular or angled holes in straight or curved wooden handrails. The Bore Buster® is lightweight but extremely tough. It has precision pitch controls and fits LJ-6010, LJ-6109, LJ-6210, LJ-6400, LJ-6519, LJ-6601, LJ-6701, LJ-6900, LJ-6A10 and LJ-6B10 handrail profiles. This tool permits fast, accurate rail bolt holes to be drilled. The Bore Buster® fits most power drills and our **LJ-3031 Chuck-Buster**.



LJ-3060 Bore Buster®
Comes in a hard carrying case and includes:

- LJ-3031 Chuck-Buster**
9/32" twist bit
3/8" twist bit
5/8" Bore Buster® bit
3/4" Bore Buster® bit
1" Bore Buster® bit
Bit file



LJ-3061 Bore Buster® Plus
Comes in a hard carrying case and includes:
LJ-3060 Bore Buster® & accessories
3/8" electric drill
LJ-3032 Rail Bolt-Runner
LJ-3033 Dowel-Runner®
LJ-3035 Centaur®
LJ-3036 Dowel-Fast Tap
LJ-3044 VersaTool™

Tool Bag and Tool Packs



LJ-3062 Tool Bag — This rugged canvas bag is tough enough to handle all of your stairway installation tools...plus anything else you want to throw in!!! Add either of our tool packs, or fill it with any combination of our stairway installation tools and hardware. We've tested it with both of our tool packs and all of our other tools, and there's still room left for your drill, tape measure and much more. Bag Dimensions: 12" (305 mm) deep x 10" (254 mm) wide x 25" (635 mm) long



LJ-3064 Tool Pack 1 — Includes:
LJ-3031 Chuck-Buster
LJ-3032 Rail Bolt-Runner
LJ-3033 Dowel-Runner®
LJ-3034 Screw-Runner
LJ-3035 Centaur™
LJ-3036 Dowel-Fast Tap
LJ-3044 VersaTool™
LJ-3085 Insert-Runner
LJ-3047 Telescoping Baluster Marking Tool



LJ-3066 Tool Pack 2 — Includes:
LJ-3049 Drill Bit Pack
LJ-3052 Stair Wizard™
LJ-3084 Baluster Runner™ Set

Custom Capabilities





- ① Carved Turnings
- ② Acrylic Balusters
- ③ Stacked Starting Steps
- ④ Bowed Starting Steps
- ⑤ Bowed Treads
- ⑥ Bowed Risers
- ⑦ Custom Treads
- ⑧ Curved Treads
- ⑨ Curved Shoe Mould
- ⑩ Curved Cove Mould
- ⑪ Winder Treads
- ⑫ Platforms
- ⑬ Transition Fittings
- ⑭ Custom Carvings
- ⑮ Custom Component Fittings
- ⑯ Curved Handrail
- ⑰ Shaped Handrail
- ⑱ Shaped Shoerail
- ⑲ Curved Landing Tread
- ⑳ Shaped Landing Tread
- ㉑ Oversized Landing Tread
- ㉒ Custom Designs

Call (740) 269-2221 for a quote or more information.

Ordering Guidelines



Post to Post

WOOD POST TO POST STAIR SYSTEM

The following guidelines are designed to provide an accurate and complete list of components necessary to complete your Wood Post to Post Stair System. This checklist will provide the flexibility to comply with most building codes as they relate to handrail height and baluster spacing requirements. The following guidelines will achieve 34" - 38" rake rail heights. Always check local building codes before installation. All products in this catalog are for interior installations only.

Item	Guidelines	Page	Part #	Qty.
1	SKIRTBOARD Select skirtboard at 13" per tread, plus any additional length desired for extension beyond the first and last risers. Be sure to order enough skirtboard for both sides of the stairway.	80		
2	TREADS Select one tread for each step. For a stair open on one side order miter-returned (MR1) and add 1/4" to the skirtboard to skirtboard measurement, then refer to the next longer standard length available. For a stair open both sides order miter-returned both (MR2) and use the finished skirtboard to skirtboard measurement (measured outside to outside). For false treads see page 81.	80-81		
3	RISERS Select one riser for each step. Select one more riser than treads per each flight because of landing tread (see #4). Note: Landing tread replaces the nosing over the last riser. For false risers see page 81.	80-81		
4	LANDING TREAD Select sufficient lineal footage for the entire balcony and width of stairs at each landing. Note: LJ-8090-5 is suitable for all newels up to and including those that are 4" square. Larger newel posts might require the addition of a wood strip.	80		
5	COVE MOULD Select sufficient lineal footage to go under all tread nosing (including miter-returns) and under all landing tread. Note: cove moulding is not needed under false treads.	80		
6	UTILITY NEWEL For stairs with a 34"-38" rake rail height, select the 58" Utility newel for the starting newel. If handrail and balusters will be installed on both sides of the bottom of the stairway, two of these newels will be needed. See the Post to Post Newel Applications chart at the bottom of this page for further information on Utility Newel applications. If using Box Newels, select one for the starting newel at the bottom of the stairway. If handrail and balusters will be installed on both sides of the bottom of the stairway, two of these newels will be needed.	20-34 36-41		
7	PIN NEWEL Use in the middle of a long rake run of handrail for strength. This newel does not require a handrail fitting. Pin newels are available in two turning styles only.	28-29,32		
8	INTERMEDIATE LANDING NEWEL Select the intermediate landing newel with the 14 1/2" face when <u>not</u> using a landing fitting assembly (gooseneck). If a landing fitting assembly is used, select the 5" face intermediate landing newel. See the Post to Post Newel Applications chart at the bottom of this page for selecting the appropriate Intermediate Landing Newel(s) for your application. Refer to the photos on page 12. If using Box Newels, select an Intermediate Box Newel. Matching the Box Newel chosen in #6 may require adding additional length to the bottom of the post when used at the intermediate landing.	20-34 36-41		
9	SECOND FLOOR LANDING NEWEL Select the 2nd Floor Landing Newel when <u>not</u> using a landing fitting assembly (36" balcony height). 42" balcony height requires the use of a landing fitting assembly. Use the 48" Utility Newel for surface mount when using a landing fitting assembly. If the newel extends below the floor surface, use the 58" Utility Newel with a landing fitting assembly. See the applications chart below... If using Box Newels, select a Box Newel or Intermediate Box Newel for the Second Floor Landing Newel.	20-34 36-41		
10	LEVEL RUN NEWEL A level run, whether on the 2nd floor or at an intermediate landing, must include newel posts. It should match the post selected for the transition from rake to level or rake to rake (whichever is applicable). For a run of 10 feet or more, use a newel at the midpoint or every 5 to 6 feet. Place a newel at every corner.	20-41		
11	HALF NEWEL OR ROSETTES Select the half-newel of the same style as the other full newels selected on the balcony (i.e.: 11" face or 5" face or Box Newel) Select the round rosette for all level run rail connections into a wall. Select the oval or rectangular rosette for all angled rail connections into a wall (when the rail meets the wall on a rake).	20-41 81		
12	NEWEL MOUNTING HDWE Select one of the newel mounting kits for each newel post.	84		
14	RAKE BALUSTERS FOR OPEN TREAD STAIR "LJ-" Series Balusters: For 34"-38" handrail height, use the 38" baluster for the 1st baluster on the tread and use the 42" baluster for the 2nd baluster on the tread. If using three balusters per tread, use the 38" baluster for the 1st and 2nd balusters on the tread, and use the 42" baluster for the 3rd baluster on the tread. Note: when using three balusters per tread for 34"-38" rail height, the 42" baluster may <u>not</u> be long enough for use under a landing fitting assembly (gooseneck). "S-" Series Balusters: For 34"-38" rake handrail height, the first baluster on each tread is 36", the 2nd is 42", and if 3 balusters are used, the middle baluster is 39".	19-34 27,31		
15	RAKE BALUSTERS FOR KNEEWALL STAIR "LJ-" Series Balusters: Select the shortest available baluster at a rate of two or three per tread equally spaced according to code requirements. Subtract one baluster from the calculated total as the starting newel replaces the first baluster. "S-" Series Balusters: Select the shortest available baluster at a rate of two or three per tread equally spaced according to code requirements. Subtract one baluster from the calculated total as the starting newel replaces the first baluster.	19-34 27,31		
16	LEVEL RUN BALUSTERS "LJ-" Series Balusters: Use the 38" baluster for all 36" level runs/balconies. Use the 42" baluster for all 42" level runs/balconies. To determine quantity of balusters needed, measure the total distance between the end newels on each level run. Place balusters on 4" or 6" centers. Subtract one baluster from the calculated total to account for the end of the run. Subtract one baluster for each newel post on the level run. Do not, however, subtract one for the newel post beneath the landing fitting assembly (gooseneck) at the 2nd floor landing. "S-" Series Balusters: Use the 36" baluster for all 36" level runs/balconies. Use the 42" baluster for all 42" level runs/balconies. To determine quantity of balusters needed, measure the total distance between the end newels on each level run. Place balusters on 4" or 6" centers. Subtract one baluster from the calculated total to account for the end of the run. Subtract one baluster for each newel post on the level run. Do not, however, subtract one for the newel post beneath the landing fitting assembly (gooseneck) at the 2nd floor landing.	19-34 27,31		
17	HANDRAIL Select handrail at a rate of 13" per each tread and include enough for all level runs. Our handrails are available in 8', 10', 12', 14', & 16' lengths. Some are also available in 18' & 20' lengths. See #18 for calculating wall rail.	19-34,82		
18	WALL RAIL If local building codes require wall rail, select wall rail at a rate of 13" per each tread that is closed by a wall. Also, see #20 below. Note: any of our non-plowed handrail profiles may be used as wall rail, however, be sure to check with local building codes for space requirements between the rail and the wall. Wall rail requires wall rail brackets (see #25). Select one bracket for each end of the rail and at 2'-3" intervals between.	83 19-34 82		
19	HANDRAIL FITTINGS (Landing Fitting Components) If using a Landing Fitting Assembly (gooseneck) with the Intermediate and/or Second Floor Landing Newels, match each corner of the floor plan to a corresponding plan on pages 77-78. Specify each Conect-A-Kit fitting component needed to construct the Landing Fitting Assembly(ies) or select traditional gooseneck fittings.	77-78		
20	HANDRAIL FITTINGS (Miscellaneous Components) If continuous handrail is needed to transition from the rake balusters, around a wall, and continue up the stair as wall rail, select the appropriate "S" Fitting or select two level quarterturns.	75-76		
21	SHOERAIL FOR KNEEWALL STAIR/LEVEL RUN Select shoerail at a rate of 13" per each tread on kneewall. Select shoerail to cover all balcony landing tread, (if desired).	19-34		
22	FILLET Select enough fillet to fill all plowed handrail and all shoerail.	19-34		
23	DOUBLE-END SCREW Select one Dowel-Fast™ double-end wood screw for each baluster installed on open treads or level landings. This is optional, but highly recommended. Double-end wood screws are not needed for balusters installed within shoerail.	85		
24	BRACKETS (Open Stairs) Select one bracket for each tread, (if desired).	81		
25	HARDWARE See pages 83-85 for any other installation hardware needed, such as, but not limited to, the following: Flush Mount Kit or Rail & Post Fastener to fasten the handrail to the newel posts; Wall Rail Brackets for any handrail attached to the wall; Wood Plugs, Wood Putty or Wood Glue.	83-85		

Post to Post Newel Applications

Each Post to Post newel series includes several newels of different lengths. The application for the newels in each series is identified below.

Shortest Utility Newel (48"—5" top face)	May be used as the starting newel on stairs depending on handrail profile and code requirements. Can be used as a balcony newel that is surface mounted.
Longest Utility Newel (58"—5" top face)	Use this newel as a starting newel for stairs with a 34"-38" rake rail height and for balcony newels that will extend below the floor surface.
2nd Floor Landing Newel (11" top face)	Use this newel for the 2nd floor landing newel when not using a landing fitting assembly (gooseneck). Will achieve a 36" balcony railing height.
Intermediate Landing Newel (73" overall—14 1/2" top face)	Use this newel for a level intermediate landing with <u>no</u> landing fitting assembly (gooseneck).
Intermediate Landing Newel (78" overall—5" top face)	Use this newel at the intermediate landing corner of an L-shaped stair with a landing fitting assembly (gooseneck), including landings with 2-winder or 3-winder treads. This newel is also available in 62" and 73" lengths for the Cornerstone Collection on pages 31-32.

IRON & WOOD POST TO POST STAIR SYSTEM

The following guidelines are designed to provide an accurate and complete list of components necessary to complete your Iron & Wood Post to Post Stair System. This checklist will provide the flexibility to comply with most building codes as they relate to handrail height and baluster spacing requirements. The following guidelines will achieve 34" - 38" rake rail heights. Always check local building codes before installation. All products in this catalog are for interior installations only.

Item	Guidelines	Page	Part #	Qty
SUPPORT SYSTEM				
1	SKIRTBOARD	Select skirtboard at 13" per tread, plus any additional length desired for extension beyond the first and last risers. Be sure to order enough skirtboard for both sides of the stairway.	80	
2	TREADS	Select one tread for each step. For a stair open on one side order miter-returned (MR1) and add 1 1/4" to the skirtboard to skirtboard measurement, then refer to the next longer standard length available. For a stair open both sides order miter-returned both (MR2) and use the finished skirtboard to skirtboard measurement (measured outside to outside). For false treads see page 81.	80-81	
3	RISERS	Select one riser for each step. Select one more riser than treads per each flight because of landing tread (see #4). Note: Landing tread replaces the nosing over the last riser. For false risers see page 81.	80-81	
4	LANDING TREAD	Select sufficient lineal footage for the entire balcony and width of stairs at each landing. Note: LJ-8090-5 is suitable for all newels up to and including those that are 4" square. Larger newel posts might require the addition of a wood strip.	80	
5	COVE MOULD	Select sufficient lineal footage to go under all tread nosing (including miter-returns) and under all landing tread. Note: cove moulding is not needed under false treads.	80	
BALUSTRADE				
6	UTILITY NEWEL	For stairs with a 34"-38" rake rail height, select the 58" Utility newel for the starting newel. If handrail and balusters will be installed on both sides of the bottom of the stairway, two of these newels will be needed. See the Post to Post Newel Applications chart at the bottom of this page for further information on Utility Newel applications.	20-34	
		If using Box Newels, select one for the starting newel at the bottom of the stairway. If handrail and balusters will be installed on both sides of the bottom of the stairway, two of these newels will be needed.	36-41	
7	PIN NEWEL	Use in the middle of a long rake run of handrail for strength. This newel does not require a handrail fitting. Pin newels are available in two turning styles only.	28-29,32	
8	INTERMEDIATE LANDING NEWEL	Select the intermediate landing newel with the 14 1/2" face when <u>not</u> using a landing fitting assembly (gooseneck). If a landing fitting assembly is used, select the 5" face intermediate landing newel. See the Post to Post Newel Applications chart at the bottom of this page for selecting the appropriate Intermediate Landing Newel(s) for your application. Refer to the photos on page 12.	20-34	
		If using Box Newels, select an Intermediate Box Newel. Matching the Box Newel chosen in #6 may require adding additional length to the bottom of the post when used at the intermediate landing.	36-41	
9	SECOND FLOOR LANDING NEWEL	Select the 2nd Floor Landing Newel when <u>not</u> using a landing fitting assembly (36" balcony height). 42" balcony height requires the use of a landing fitting assembly. Use the 48" Utility Newel for surface mount when using a landing fitting assembly. If the newel extends below the floor surface, use the 58" Utility Newel with a landing fitting assembly. See the Newel Applications chart below...	20-34	
		If using Box Newels, select a Box Newel or Intermediate Box Newel for the Second Floor Landing Newel.	36-41	
10	LEVEL RUN NEWEL	A level run, whether on the 2nd floor or at an intermediate landing, must include newel posts. It should match the post selected for the transition from rake to level or rake to rake (whichever is applicable). For a run of 10 feet or more, use a newel at the midpoint or every 5 to 6 feet. Place a newel at every corner.	20-41	
11	HALF NEWEL OR ROSETTES	Select the half-newel of the same style as the other full newels selected on the balcony (i.e.: 11" face or 5" face or Box Newel)	20-41	
12	NEWEL MOUNTING HARDWARE	Select the round rosette for all level run rail connections into a wall. Select the oval or rectangular rosette for all angled rail connections into a wall (when the rail meets the wall on a rake).	81	
13	NEWEL MOUNTING HARDWARE	Select one of the newel mounting kits for each newel post.	84	
14	RAKE IRON BALUSTERS FOR OPEN TREAD STAIR	Use three iron balusters per tread equally spaced according to code requirements. While not necessary, an alternating pattern is frequently desired. Note: Scroll style balusters cannot be used three per tread.	57-67	
15	RAKE IRON BALUSTERS FOR KNEEWALL STAIR	Select iron balusters at a rate of three per tread equally spaced according to building code compliance. Subtract one baluster from the calculated total as the starting newel replaces the first baluster. While not necessary, an alternating pattern is frequently desired.	58,61	
16	LEVEL RUN IRON BALUSTERS	To determine quantity of balusters needed, measure the total distance between the end newels on each level run. Place iron balusters equally spaced according to building code compliance. Subtract one baluster from the calculated total to account for the end of the run. Subtract one baluster for each newel post on the level run. Do not, however, subtract one for the newel post beneath the landing fitting assembly (gooseneck) at the 2nd floor landing. While not necessary, an alternating pattern is frequently desired.	57-67	
17	HANDRAIL	Select non-plowed handrail at a rate of 13" per each tread and include enough for all level runs. Our handrails are available in 8', 10', 12', 14', & 16' lengths. Some are also available in 18' & 20' lengths. See #18 for calculating wall rail.	19-34, 82	
18	WALL RAIL	If local building codes require wall rail, select wall rail at a rate of 13" per each tread that is closed by a wall. Also, see #20 below. Note: any of our non-plowed handrail profiles may be used as wall rail, however, be sure to check with local building codes for space requirements between the rail and the wall. Wall rail requires wall rail brackets (see #26). Select one bracket for each end of the rail and at 2'-3" intervals between.	83	
			19-34, 82	
19	HANDRAIL FITTINGS (Landing Fitting Components)	If using a Landing Fitting Assembly (gooseneck) with the Intermediate and/or Second Floor Landing Newels, match each corner of the floor plan to a corresponding plan on pages 77-78. Specify each Connect-A-Kit fitting component needed to construct the Landing Fitting Assembly(ies) or select traditional gooseneck fittings.	77-78	
20	HANDRAIL FITTINGS (Miscellaneous Components)	If continuous handrail is needed to transition from the rake balusters, around a wall, and continue up the stair as wall rail, select the appropriate "S" Fitting or select two level quarterturns.	75-76	
21	BOTTOM BALUSTER COLLARS	Select one bottom baluster collar for each baluster. See descriptions for applications.	57-67	
22	TOP BALUSTER COLLARS	Select one top baluster collar for each baluster (if desired). See descriptions for applications.	57-67	
23	IRON BALUSTER ACCESSORIES	If using PLA44 balusters, select the appropriate number of adjustable knuckles (if desired). If medallion balusters are being used, select the corresponding number of medallions (if desired).	58,60	
24	BRACKETS (Open Stairs)	Select one bracket for each tread, (if desired).	81	
25	IRON BALUSTER EPOXY	Select construction epoxy for installing the iron balusters.	71	
26	HARDWARE	See pages 83-85 for any other installation hardware needed, such as, but not limited to, the following: Flush Mount Kit or Rail & Post Fastener to fasten the handrail to the newel posts; Wall Rail Brackets for any handrail attached to the wall; Wood Plugs, Wood Putty or Wood Glue.	83-85	

Post to Post Newel Applications

Each Post to Post newel series includes several newels of different lengths. The application for the newels in each series is identified below.

Shortest Utility Newel (48"—5" top face)	May be used as the starting newel on stairs depending on handrail profile and code requirements. Can be used as a balcony newel that is surface mounted.
Longest Utility Newel (58"—5" top face)	Use this newel as a starting newel for stairs with a 34"-38" rake rail height and for balcony newels that will extend below the floor surface.
2nd Floor Landing Newel (11" top face)	Use this newel for the 2nd floor landing newel when not using a landing fitting assembly (gooseneck). Will achieve a 36" balcony railing height.
Intermediate Landing Newel (73" overall—14 1/2" top face)	Use this newel for a level intermediate landing with <u>no</u> landing fitting assembly (gooseneck).
Intermediate Landing Newel (78" overall—5" top face)	Use this newel at the intermediate landing corner of an L-shaped stair with a landing fitting assembly (gooseneck), including landings with 2-winder or 3-winder treads. This newel is also available in 62" and 73" lengths for the Cornerstone Collection on pages 31-32.

Ordering Guidelines



WOOD OVER THE POST STAIR SYSTEM

The following guidelines are designed to provide an accurate and complete list of components necessary to complete your Wood Over the Post Stair System. This checklist will provide the flexibility to comply with most building codes as they relate to handrail height and baluster spacing requirements. The following guidelines will achieve 34" - 38" rake rail heights. Always check local building codes before installation. All products in this catalog are for interior installations only.

Item	Guidelines	Page	Part #	Qty
1 SKIRTBOARD	Select skirtboard at 13" per tread, plus any additional length desired for extension beyond the first and last risers. Be sure to order enough skirtboard for both sides of the stairway.	80		
2 STARTING STEP	For use with volutes and turnouts. Select a single or double bullnose starting step matching your floor plan to those shown on page 79. Be sure to select a starting step that coordinates with the chosen volute(s) and turnout(s). Measure finished skirtboards from outside to outside. For false starting steps see page 81.	79,81		
3 TREADS	Select one tread for each step (except the starting step). For a stair open on one side order miter-returned (MR1) and add 1 1/4" to the skirtboard to skirtboard measurement, then refer to the next longer standard length available. For a stair open both sides order miter-returned both (MR2) and use the finished skirtboard to skirtboard measurement (measured outside to outside). For false treads see page 81.	80-81		
4 RISERS	Select one riser for each step (except the starting step). Select one more riser than treads per each flight because of landing tread (see #5). Landing tread replaces the nosing over the last riser. For false risers see page 81.	80-81		
5 LANDING TREAD	Select sufficient lineal footage for the entire balcony and width of stairs at each landing. Note: LJ-8090-5 is suitable for all newels up to and including those that are 4" square. Larger newel posts might require the addition of a wood strip.	80		
6 COVE MOULD	Select sufficient lineal footage to go under all tread nosing (including miter-returns) and under all landing tread. Note: cove moulding is not needed under false treads.	80		
7 STARTING FITTING	Select either a standard volute, vertical volute, turnout, or starting easing with cap. Choose a climbing volute to eliminate the need for an unusually long starting newel.	73-74		
8 PIN NEWEL	Use under a vertical volute. This newel is also used in the middle of a long rake run of handrail for strength (does not require a handrail fitting). Pin newels are available in two turning styles only.	52, 54-55		
9 UTILITY NEWEL (43")	Use everywhere except at the intermediate landing corner of an L-shaped stair and in situations listed in #8 above.	44-55		
10 UTILITY NEWEL (50")	Use for balcony newel(s) that will extend below the floor surface. Also use under a starting easing with cap when a starting step is <u>not</u> used, and the rake handrail height is 34" or higher.	44-55		
11 INTERMEDIATE LANDING NEWEL	Use the 58" intermediate landing newel at the intermediate landing corner of an L-shaped stair. Use the 73" intermediate landing newel in 2-winder or 3-winder situations. A 65" intermediate landing newel is also available in the Cornerstone Collection on pages 53-54.	44-55		
12 LEVEL RUN NEWEL	If the balcony is 10 feet or longer, use the 43" utility newel every 5 or 6 feet under a tandem cap. Place a newel at every corner under a quarterturn with cap. Use the 50" utility newel if the newel is to extend below the 2nd floor surface.	44-55		
13 HALF NEWEL OR ROSETTES	Select the half-newel of the same style as the other full newels selected on the balcony.	44-55		
14 ROSETTES	Select the round rosette for all level run rail connections into a wall. Select the oval or rectangular rosette for all angled rail connections into a wall (when the rail meets the wall on a rake).	81		
15 NEWEL MOUNTING HDWE	Select one of the newel mounting kits for each newel post.	84		
16 BALUSTERS FOR VOLUTES AND TURNOUTS	"LJ-" Series Balusters: Standard volutes require four or six 1 1/4" balusters, or four 1 1/4" balusters. Turnouts require two 1 1/4" balusters, or one 1 1/4" balusters. For 34"-38" rake rail height, use 42" balusters under all standard volutes and turnouts. Climbing volute requirements: For 34" rake rail height, use three 38" and one or two 42" baluster(s). For 36" rake rail height, use four or five 42" balusters.	43-55		
	"S-" Series Balusters: For 34"-38" rake rail height, use 42" balusters under standard volutes and turnouts.	51,53		
17 BALUSTERS FOR STARTING EASING WITH CAP	"LJ-" Series Balusters: Use one 42" baluster for 34"-38" handrail height.	43-55		
	"S-" Series Balusters: Use one 42" baluster for 34"-38" handrail height.	51,53		
18 RAKE BALUSTERS FOR OPEN TREAD STAIR	"LJ-" Series Balusters: For 34"-38" handrail height, use the 38" baluster for the 1st baluster on the tread and use the 42" baluster for the 2nd baluster on the tread. If using three balusters per tread, use the 38" baluster for the 1st and 2nd balusters on the tread, and use the 42" baluster for the 3rd baluster on the tread. Note: when using three balusters per tread for 34"-38" rail height, the 42" baluster may not be long enough for use under a landing fitting assembly.	43-55		
	"S-" Series Balusters: For 34"-38" rake handrail height, the first baluster on each tread is 36", the 2nd is 42", and if 3 balusters are used, the middle baluster is 39".	51,53		
19 RAKE BALUSTERS FOR KNEEWALL STAIR	"LJ-" Series Balusters: Select the shortest available baluster at a rate of two or three per tread equally spaced according to building code compliance. Subtract one baluster from the calculated total as the starting newel replaces the first baluster.	43-55		
	"S-" Series Balusters: Select the shortest available baluster at a rate of two or three per tread equally spaced according to building code compliance. Subtract one baluster from the calculated total as the starting newel replaces the first baluster.	51,53		
20 LEVEL RUN BALUSTERS	"LJ-" Series Balusters: Use the 38" baluster for all 36" level runs/balconies. Use the 42" baluster for all 42" level runs/balconies (exception: an over the post rake rail height of 34"-38" requires 42" balusters for 36" and 42" level balconies). To determine quantity of balusters needed, measure the total distance between the end newels on each level run. Place balusters equally spaced according to building code compliance. Subtract one baluster from the calculated total to account for the end of the run. Subtract one baluster for each newel post on the level run. Do not, however, subtract one for the newel post beneath the landing fitting assembly (gooseneck) at the 2nd floor landing.	43-55		
	"S-" Series Balusters: Use the 36" baluster for all 36" level runs/balconies. Use the 42" baluster for all 42" level runs/balconies. To determine quantity of balusters needed, measure the total distance between the end newels on each level run. Place balusters equally spaced according to building code compliance. Subtract one baluster from the calculated total to account for the end of the run. Subtract one baluster for each newel post on the level run. Do not, however, subtract one for the newel post beneath the landing fitting assembly (gooseneck) at the 2nd floor landing.	51,53		
21 HANDRAIL	Select handrail at a rate of 13" per each tread and include enough for all level runs. Our handrails are available in 8', 10', 12', 14', & 16' lengths. Some are also available in 18' & 20' lengths. See #22 for calculating wall rail.	43-55 82		
22 WALL RAIL	If local building codes require wall rail, select wall rail at a rate of 13" per each tread that is closed by a wall. Also see #24 below. Note: any of our non-plowed handrail profiles may be used as wall rail, however, be sure to check with local building codes for space requirements between the rail and the wall. Wall rail requires wall rail brackets (see #29). Select one bracket for each end of the rail and at 2'-3" intervals between.	83 43-55 82		
23 HANDRAIL FITTINGS (Landing Fitting Components)	Match each corner of the floor plan to a corresponding plan on pages 77-78. Specify each Conect-A-Kit fitting component needed to construct the Landing Fitting Assembly(ies) or select traditional gooseneck fittings.	77-78		
24 HANDRAIL FITTINGS (Miscellaneous Components)	Each newel must be covered with a fitting. Select an opening cap for each half-newel (this fitting will be cut on the job). If continuous handrail is needed to transition from the rake balusters, around a wall, and continue up the stair as wall rail, select the appropriate "S" Fitting or selected two level quarterturns.	75-76		
25 SHOERAIL FOR KNEEWALL STAIR/LEVEL RUN	Select shoerail at a rate of 13" per each tread on the kneewall. Select shoerail to cover all balcony landing tread, (if desired).	43-55		
26 FILLET	Select enough fillet to fill all plowed handrail and all shoerail.	43-55		
27 DOUBLE-END SCREW	Select one Dowel-Fast™ double-end wood screw for each baluster installed on open treads or level landings. This is optional, but highly recommended. Double-end wood screws are not needed for balusters installed within shoerail.	85		
28 BRACKETS (Open Stairs)	Select one bracket for each tread, (if desired).	81		
29 HARDWARE	See pages 83-85 for any other installation hardware needed, such as, but not limited to, the following: Wall Rail Brackets for any handrail attached to the wall; Wood Plugs, Wood Putty or Wood Glue.	83-85		

Over the Post Newel Applications Each Over the Post newel series includes several newels of different lengths. The application for the newels in each series is identified below.

Shortest Utility Newel (43")	Use this newel under all starting fittings (except Vertical Volutes and Starting Easings with Cap), and as a balcony newel that is surface mounted. (see "Longest Utility Newel" for exception on Starting Easing with Cap)
Longest Utility Newel (50")	Use this newel under a Starting Easing with Cap when a starting step is not used and the rake handrail height is 34" or higher. Can also be used as a balcony newel that will extend below the floor surface.
Intermediate Landing Newel (58")	Use this newel for level intermediate landings.
Intermediate Landing Newel (73")	Use this newel for intermediate landings with 2-winder or 3-winder treads. This newel is also available in 65" length for the Cornerstone Collection on pages 53-54.

Ordering Guidelines



IRON & WOOD OVER THE POST STAIR SYSTEM

The following guidelines are designed to provide an accurate and complete list of components necessary to complete your Iron & Wood Over the Post Stair System. This checklist will provide the flexibility to comply with most building codes as they relate to handrail height and baluster spacing requirements. The following guidelines will achieve 34" - 38" rake rail heights. Always check local building codes before installation. All products in this catalog are for interior installations only.

Item	Guidelines	Page	Part #	Qty
SUPPORT SYSTEM				
1	SKIRTBOARD Select skirtboard at 13" per tread, plus any additional length desired for extension beyond the first and last risers. Be sure to order enough skirtboard for both sides of the stairway.	80		
2	STARTING STEP For use with volutes and turnouts. Select a single or double bullnose starting step matching your floor plan to those shown on page 79. Be sure to select a starting step that coordinates with the chosen volute(s) and turnout(s). Measure finished skirtboards from outside to outside. For false starting steps see page 81.	79,81		
3	TREADS Select one tread for each step (except the starting step). For a stair open on one side order miter-returned (MR1) and add 1/4" to the skirtboard to skirtboard measurement, then refer to the next longer standard length available. For a stair open both sides order miter-returned both (MR2) and use the finished skirtboard to skirtboard measurement (measured outside to outside). For false treads see page 81.	80-81		
4	RISERS Select one riser for each step (except the starting step). Select one more riser than treads per each flight because of landing tread (see #5). Landing tread replaces the nosing over the last riser. For false risers see page 81.	80-81		
5	LANDING TREAD Select sufficient lineal footage for the entire balcony and width of stairs at each landing. Note: LJ-8090-5 is suitable for all newels up to and including those that are 4" square. Larger newel posts might require the addition of a wood strip.	80		
6	COVE MOULD Select sufficient lineal footage to go under all tread nosing (including miter-returns) and under all landing tread. Note: cove moulding is not needed under false treads.	80		
BALUSTRADE				
7	STARTING FITTING Select either a standard volute, vertical volute, turnout, or starting easing with cap. Choose a climbing volute to eliminate the need for an unusually long starting newel.	73-74		
8	IRON NEWEL Iron newels can only be used as starting newels at the bottom of the stairway because they require a starting step for installation. If handrail and balusters will be installed on both sides, two of these newels will be needed. See steps #9, #10 & #11 below if using wood newels as the starting newels.	68		
9	WOOD PIN NEWEL Use under a vertical volute. This newel is also used in middle of a long rake run of handrail for strength (does not require a handrail fitting). Pin newels are available in two turning styles only.	52, 54-55		
10	WOOD UTILITY NEWEL (43") Use everywhere except at the intermediate landing corner of an L-shaped stair and in situations listed in #9 above. See the Over the Post Newel Applications chart at the bottom of the previous page for further information on over the post wood newel applications.	44-55		
11	WOOD UTILITY NEWEL (50") Use for balcony newel(s) that will extend below the floor surface. Also use under a starting easing with cap when a starting step is not used, and the rake handrail height is 34" or higher.	44-55		
12	WOOD INTERMEDIATE LANDING NEWEL Use the 58" intermediate landing newel at the intermediate landing corner of an L-shaped stair. Use the 73" intermediate landing newel in 2-winder or 3-winder situations. A 65" intermediate landing newel is also available in the Cornerstone Collection on pages 53-54.	44-55		
13	WOOD LEVEL RUN NEWEL If the balcony is 10 feet or longer, use the 43" utility newel every 5 or 6 feet under a tandem cap. Place a newel at every corner under a quarterturn with cap. Use the 50" utility newel if the newel is to extend below the 2nd floor surface.	44-55		
14	WOOD HALF NEWEL OR ROSETTES Select the half-newel of the same style as the other full newels selected on the balcony.	44-55		
15	ROSETTES Select the round rosette for all level run rail connections into a wall. Select the oval or rectangular rosette for all angled rail connections into a wall (when the rail meets the wall on a rake).	81		
16	NEWEL MOUNTING HARDWARE Select an Iron Newel Mounting Kit for each iron newel being used. Select one of the newel mounting kits for each wood newel post being used.	68 84		
17	IRON BALUSTERS FOR VOLUTES AND TURNOUTS Standard volutes require six iron balusters. Climbing volutes require five iron balusters. Turnouts require two iron balusters. Scroll balusters cannot be used under volutes or turnouts.	57-67		
18	IRON BALUSTERS FOR STARTING EASING WITH CAP Use one iron baluster under each Starting Easing with Cap.	57-67		
19	RAKE IRON BALUSTERS FOR OPEN TREAD STAIR Use three iron balusters per tread equally spaced according to code requirements. While not necessary, an alternating pattern is frequently desired. Note: Scroll style balusters cannot be used three per tread.	57-67		
20	RAKE IRON BALUSTERS FOR KNEEWALL STAIR Select iron balusters at a rate of three per tread and spaced according to building code compliance. Subtract one baluster from the calculated total as the starting newel replaces the first baluster. While not necessary, an alternating pattern is frequently desired. Please check building codes for baluster spacing compliance.	58,61		
21	LEVEL RUN IRON BALUSTERS To determine quantity of balusters needed, measure the total distance between the end newels on each level run. Place iron balusters equally spaced according to building code compliance. Subtract one baluster from the calculated total to account for the end of the run. Subtract one baluster for each newel post on the level run. Do not, however, subtract one for the newel post beneath the landing fitting assembly (gooseneck) at the 2nd floor landing. While not necessary, an alternating pattern is frequently desired.	57-67		
22	HANDRAIL Select handrail at a rate of 13" per each tread and include enough for all level runs. Our handrails are available in 8', 10', 12', 14', & 16' lengths. Some are also available in 18' & 20' lengths. See #23 for calculating wall rail.	43-55 82		
23	WALL RAIL If local building codes require wall rail, select wall rail at a rate of 13" per each tread that is closed by a wall. See #25 below. Note: any of our non-plowed handrail profiles may be used as wall rail, however, be sure to check with local building codes for space requirements between the rail and the wall. Wall rail requires wall rail brackets (see #31). Select one bracket for each end of the rail and at 2'-3' intervals between.	83 43-55 82		
24	HANDRAIL FITTINGS (Landing Fitting Components) Match each corner of the floor plan to a corresponding plan on pages 77-78. Specify each Connect-A-Kit fitting component needed to construct the Landing Fitting Assembly(ies) or select traditional gooseneck fittings.	77-78		
25	HANDRAIL FITTINGS (Miscellaneous Components) Each newel must be covered with a fitting. Select an opening cap for each half-newel (this fitting will be cut on the job). If continuous handrail is needed to transition from the rake balusters, around a wall, and continue up the stair as wall rail, select the appropriate "S" Fitting or select 2 level quarterturns.	75-76		
26	BOTTOM BALUSTER COLLARS Select one bottom baluster collar for each baluster. See descriptions for applications.	57-67		
27	TOP BALUSTER COLLARS Select one top baluster collar for each baluster (if desired). See descriptions for applications.	57-67		
28	IRON BALUSTER ACCESSORIES If using PLA44 balusters, select the appropriate number of adjustable knuckles (if desired). If medallion balusters are being used, select the corresponding number of medallions (if desired).	58,60		
29	BRACKETS (Open Stairs) Select one bracket for each tread, (if desired).	81		
30	IRON BALUSTER EPOXY Select construction epoxy for installing the iron balusters.	71		
31	HARDWARE See pages 83-85 for any other installation hardware needed, such as, but not limited to, the following: Wall Rail Brackets for any handrail attached to the wall; Wood Plugs, Wood Putty or Wood Glue.	83-85		

Over the Post

The all new LJSmith.com website has a modern new look with updated photos throughout. The responsive design adjusts and responds to various screen sizes and renders beautifully across desktops, laptops, tablets and mobile phones...



The new product navigation menu allows quick access to the products you are looking for.



Product filtering by various attributes such as brand, style, square size, length, specie or finish, etc.



Stair Designer allows the user to select balustrade components and see them displayed on a stairway.



Each product detail page pictures the item in its respective wood specie/iron finish, offers alternate items and includes integrated social media sharing.



The Inspiration Galleries provide a variety of styles and new stairway ideas.

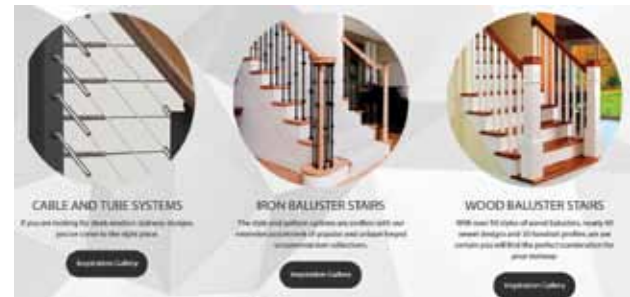

The footer on every page provides links to often requested and important information.



L.J. Smith offers a comprehensive program for marketing and selling stair systems. From our complete line of sales displays and marketing literature, to our stair training meetings, we can develop a program and supply everything needed to sell L.J. Smith products.

Sales Displays — Our wide variety of floor displays, wall displays and carousel displays offer the options necessary to sell more stair systems. Customized displays can also be made to suit your needs.



Sales Assistance & Training Meetings — Our sales representatives have all of the displays and samples that are proven as highly effective in conducting training meetings for groups both large and small. Contact your L.J. Smith rep to inquire about an educational meeting to be held at or near your place of business.

Marketing Literature
We offer a comprehensive array of marketing literature to assist in selling our products, as well as literature designed for training.



Index

WOOD BALUSTERS	PAGE
LJ-2011	23,47
LJ-2111	21,45
LJ-5004	29,55
LJ-5004ND	29,55
LJ-5005	27,51
LJ-50058	27,51
LJ-5005ND	27,51
LJ-5015/S-5015	31,53
LJ-5015ND	31,53
LJ-5035	31,53
LJ-5040/S-5040	31,53
LJ-5060/S-5060	34
LJ-5060V	34
LJ-5067/S-5067	31,53
LJ-5070	34
S-5105	27,51
LJ-5141/S-5141	31,53
LJ-5141ND	31,53
LJ-5200	29,55
LJ-5300/S-5300	27,51
LJ-53008	27,51
LJ-5360/S-5360	33
LJ-5360V	33
LJ-5370	33
LJ-5V05	30
LJ-5V15	30
LJ-5V25	30
LJ-5V35	30
LJB-2905	19,43
LJB-2915	19,43
LJC-5060	34
LJC-5060V	34
LJC-5360	33
LJC-5360V	33
LJF-2005	25,49
LJF-2015	24,49
LJF-2105	21,45
LJF-2115	21,45
LJF-2905	19,43
LJF-2915	19,43
LJF-5060	34
LJF-5060V	34
LJF-5070	34
LJF-5360	33
LJF-5360V	33
LJF-5370	33
LJP-2005	25,49
LJP-20058	25,49
LJP-2015	25,49
LJP-20158	25,49
LJP-2105	21,45
LJP-2115	21,45
LJP-2405	23,47

WOOD BALUSTERS	PAGE
LJP-2415	23,47
LJP-2905	19,43
LJP-2915	19,43
LJT-2005	25,49
LJT-2015	25,49

IRON BALUSTERS	PAGE
LI-10044	63
LI-11044	63
LI-13044	63
LI-13144	64
LI-13244	64
LI-14044	65
LI-14344	65
LI-15044	65
LI-16044	65
LI-19044	59
LI-1BASK44	57
LI-1KNUC44	57
LI-1RIB44	59
LI-1TW44	57
LI-20044	59
LI-2BASK44	57
LI-2KNUC1BASK44	57
LI-2KNUC44	57
LI-2RIB44	59
LI-2TW44	57
LI-30144	61
LI-30544	63
LI-30844	63
LI-31044	63
LI-33044	64
LI-40144	60
LI-40244	60
LI-40840	60
LI-41144	60
LI-50144	61
LI-60044	66
LI-60144	61
LI-61144	66
LI-61244	66
LI-8044	59
LI-8544	59
LI-9044	63-64
LI-DBLTW44	57
LI-PLA40BLY	61
LI-PLA44	58, 62
LI-WAVE44	61
LIH-HOL14044	65
LIH-HOL14344	65
LIH-HOL15044	65
LIH-HOL16044	65
LIH-HOL166144	62
LIH-HOL166244	62
LIH-HOL166344	62

IRON BALUSTERS	PAGE
LIH-HOL166444	62
LIH-HOL1BASK44	57
LIH-HOL1KNUC44	57
LIH-HOL1TW44	57
LIH-HOL2BASK44	57
LIH-HOL2KNUC44	57
LIH-HOL2TW44	57
LIH-HOL30144	61
LIH-HOL50144	61
LIH-HOL65044	66
LIH-HOL65144	66
LIH-HOL65244	66
LIH-HOL65344	66
LIH-HOLDBLTW44	57
LIH-HOLPLA44	58
LIH-KW1BASK44	58
LIH-KW1KNUC44	58
LIH-KW1TW44	58
LIH-KW2BASK44	58
LIH-KW2KNUC44	58
LIH-KW2TW44	58
LIH-KW50144	61
LIH-KW60144	61
LIH-MG1BASK44	67
LIH-MG1KNUC44	67
LIH-MG1TW44	67
LIH-MG2BASK44	67
LIH-MG2KNUC44	67
LIH-MG2TW44	67
LIH-MG50144	67
LIH-MGPLA44	67

NEWEL POSTS	PAGE
LI-NWL14048	68
LI-NWLBASK48	68
LI-NWLRIB48	68
LI-NWLTW48	68
LIH-NWLPLA44	68
LIH-NWLPLA48	68
LJ-3270	55
LJ-3513PT	28-29,52,55
LJ-4000	33
LJ-4000SQ	39
LJ-4001TP	39
LJ-4004	28
LJ-4004COL	28
LJ-4004RT	28
LJ-4010	54
LJ-4013PT	32,54
LJ-4040	32
LJ-4040BT	32
LJ-4050	54
LJ-4060	54
LJ-4075	36
LJ-4075NC	39

NEWEL POSTS	PAGE
LJ-4091	36
LJ-4091NC	39
LJ-4091TP	39
LJ-4092	37
LJ-4093	37
LJ-4094	37
LJ-4095	37
LJ-4096	38
LJ-4097	38
LJ-4098	40
LJ-4110	34
LJ-4110SQ	39
LJ-4150	32
LJ-4175	36
LJ-4180	32
LJ-4270	52
LJ-42708	52
LJ-4391	36
LJ-4392	37
LJ-4393	37
LJ-4394	37
LJ-4395	37
LJ-4396	38
LJ-4397	38
LJ-4500	28
LJ-45008	28
LJ-4500-COL	28
LJ-4600	29
LJ-4V40-5	30
LJB-3910	44
LJB-3940	20
LJC-4000	33
LJC-4110	34
LJF-3010	50
LJF-3040	26
LJF-3210	48
LJF-3240	24
LJF-3240BT	24
LJF-3310	46
LJF-3340	22
LJF-3340BT	22
LJF-3910	44
LJF-3940	20
LJF-4000	33
LJF-4091	36
LJF-4091NC	39
LJF-4110	34
LJP-3010	50
LJP-30108	50
LJP-3040	26
LJP-30408	26
LJP-3210	48
LJP-3240	24
LJP-3240BT	24
LJP-3310	46

NEWEL POSTS	PAGE
LJP-3340	22
LJP-3340BT	22
LJP-3910	44
LJP-3940	20
LJRA-4091	36
LJRC-4091	36
LJT-3010	50
LJT-3040	26

RAIL	PAGE
LJ-6000	23,29,31,34
LJ-6001	33
LJ-6002	23,29,31
LJ-6003	33-34
LJ-6005	19,21,25,27
LJ-6010	23,29,31,34,47,53,55
LJ-6010B	82
LJ-6010P	23,29,31,47,53,55
LJ-6039	83
LJ-6040	83
LJ-6041	83
LJ-6042	83
LJ-6109	19-34,43-55
LJ-6109B	82
LJ-6109P0	23,29,31,47,53,55
LJ-6109P1	19-27,43-51
LJ-6203	33-34
LJ-6210	19-33,43-51
LJ-6210B	82
LJ-6210P	19-30,43-51
LJ-6400	19-33,43-51
LJ-6400P	19-27,43-51
LJ-6519	19-33,43-51
LJ-6519B	82
LJ-6519P	19-30,43-51
LJ-6601	23,29,31,34,47,53,55
LJ-6601B	82
LJ-6601P	23,29,31,47,53,55
LJ-6701	19-27,43-51
LJ-6701B	82
LJ-6900	19-33,43-51
LJ-6900B	82
LJ-6900P	19-30,43-51
LJ-6A10	19-34,43-55
LJ-6A10B	82
LJ-6A10P0	23,29,31,47,53,55
LJ-6A10P1	19-27,43-51
LJ-6B10	19-34,43-55
LJ-6B10B	82
LJ-6B10P0	23,29,31,47,53,55
LJ-6B10P1	19-27,43-51
LJ-6V10	30
LJ-6V10P	30

FITTINGS	PAGE
LJ-7x08	76
LJ-7x09/S-7x09	75,77
LJ-7x10/S-7x10	73
LJ-7x11/S-7x11	75,77
LJ-7x11-135/S-7x11-135	75
LJ-7x12/S-7x12	75,77
LJ-7x13	75
LJ-7x14/S-7x14	75
LJ-7x15/S-7x15	76
LJ-7x16/S-7x16	76
LJ-7x19/S-7x19	76,77
LJ-7x20/S-7x20	76,77
LJ-7x21/S-7x21	76,77
LJ-7x21-135/S-7x21-135	76
LJ-7x30/S-7x30	74
LJ-7x31	73
LJ-7x35/S-7x35	74
LJ-7x36	73
LJ-7x38	73
LJ-7x40/S-7x40	74
LJ-7x41/S-7x41	74
LJ-7x45/S-7x45	74
LJ-7x46/S-7x46	74
LJ-7x47	76
LJ-7x48	76
LJ-7xRD	76,77
LJ-7001	83
LJ-7002	83
LJ-7003	83
LJ-7005	83
LJ-7006	83
LJ-7007	83
LJ-7023	83
LJ-7024	83
LJ-7025	83
S-7x50	77
S-7x55	77
S-7x60	77
S-7x65	77
S-7x71	77
S-7x76	77
S-7x81	77
S-7x86	77
S-7x88-2	78
S-7x90-2	78
S-7x91-2	78
S-7x92-2	78
S-7x95-2	78
S-7x97	78
S-7x99	78

STEPS, TREADS RISERS, ETC.	PAGE
BOXTRD	80
LJ-8010	79
LJ-8010-2	81
LJ-8015	79
LJ-8030	80
LJ-8040	79
LJ-8050	80
LJ-8060	79
LJ-8070	80
LJ-8070LH	80
LJ-8070MR1	80
LJ-8070MR2	80
LJ-8070RH	80
LJ-8074MR1	80
LJ-8075	80
LJ-8076	81
LJ-8078	81
LJ-8079	81
LJ-8080	80
LJ-8080-13	80
LJ-8090	80
LJ-8090-5	80
LJ-8095	80
LJ-8172	81
LJ-8179	81
LJ-8210	79
LJ-8215	79
LJ-8310	79
LJ-8310-2	81
LJ-8315	79
LJ-8422	80
LJ-8440	79
LJ-8460	79
LJ-8640	79
LJ-8660	79
LJ-8870	80
LJ-8870MR1	80
LJ-8870MR2	80
LJ-8879	81
LJ-8890-5	80
LJ-8895	80
LJ-8912	80
LJ-8950	80
S-8071LH	81
S-8071RH	81
S-8072	81

HARDWARE	PAGE
LJ-3004	84
LJ-3005	84
LJ-3006	84
LJ-3007HDWE	84
LJ-3008	84
LJ-3008-10	84

HARDWARE	PAGE
LJ-3009	84
LJ-3012	83
LJ-3019	84
LJ-3020	85
LJ-3021	85
LJ-3022	85
LJ-3023	85
LJ-3024	85
LJ-3025	85
LJ-3026	85
LJ-3027	83
LJ-3070	84
LJ-3071	84
LJ-3074	85
LJ-3075	85
LJ-3076	85
LJ-3077	84
LJ-3078	85
LJ-3079	85
LJ-3080	85
LJ-3127	83
LJ-3128	83
ZIPBOLT	86

TOOLS	PAGE
C-88	86
LJ-3031	87
LJ-3032	87
LJ-3033	87
LJ-3034	87
LJ-3035	86
LJ-3036	87
LJ-3040	88
LJ-3041	87
LJ-3043	88
LJ-3044	88
LJ-3047	86
LJ-3049	87
LJ-3052	85
LJ-3053	85
LJ-3060	88
LJ-3061	88
LJ-3062	88
LJ-3064	88
LJ-3066	88
LJ-3084	86
LJ-3085	87

ROSETTES & TRIM BRACKETS	PAGE
LJ-7026	81
LJ-7027	81
LJ-7028	81
LJ-7029	81
LJ-7033	81



A NOVO Building Products Company

35280 Scio-Bowerston Road, Bowerston, Ohio 44695

Phone: (740) 269-2221 ~ Fax: (740) 269-9047

Web Site: www.LJSmith.com ~ E-mail: ljsmith@ljsmith.net

Connect with us!



Distributed by:

